

F · S · T
FINE SCIENCE TOOLS

2023



FINE SURGICAL INSTRUMENTS FOR RESEARCH™

Letter from the Managing Partner

Dear customers,

As many of you are a part of the world's most essential biomedical research communities – I would like to begin by thanking you for your commitment and dedication to the advancements, breakthroughs, and discoveries in science. The world continues to face challenges, but the innovative minds and hearts of our customers and worldwide team gives us hope for a brighter tomorrow. There has never been a more significant moment to lead with our values – trust, teamwork, empathy, equality, and sustainability, as we are committed to walk alongside this road of optimism with you.

It is important to me that we take you on our journey as a valuable partner of Fine Science Tools. With that said, I am proud to inform you that we have incorporated two bee colonies into our office garden in Germany. The reason behind the idea is the fact that bees have a large impact on ecological growth and preservation which we as a company would like to put focus on. Our catalog cover showcases a symbolic representation of the countless contribution's bees have in relation to a number of areas in our daily lives. Bees have cultural and environmental importance as pollinators and producers of honey and medicinal products. The movement of pollen between flowers is necessary for plants to fertilize and reproduce. Bees control growth and quality of vegetation and work closely together, which is in line with Fine Science Tools striving to contribute to a greener world. Our FST hives are currently flourishing and have produced their first batch of honey which we plan on sharing with our customers.

Therefore, this year we have once again focused on expanding our product range to meet the needs of our customers. As the saying goes, "where focus goes, energy flows." Growth takes time, and it is not about the reward at the end but the values and experiences you gain on the journey and the footprints you leave behind. We have come a long way and have already left many footprints but there is still so much to do, and we are dedicated to doing our part in becoming a more sustainable company. We are extremely excited for you to embark into 2023 alongside us.

On behalf of the entire Fine Science Tools team worldwide, thank you again for your continued partnership and support for nearly 50 years.



Markus Gawenda



Markus Gawenda
Managing Partner



Hans Gawenda
Founder



Rob Gawenda
President

Please note the following information for your safety.

All surgical instruments and devices from the Fine Science Tools product range are intended exclusively for use in experimental research laboratories and facilities or in veterinary medicine. Our Customer Support is available to answer any questions you may have about the field of application and the material properties.



Scissors	3 – 35
Spring	3 – 14
Fine	15 – 28
Surgical	29 – 35
Bone Instruments	36 – 51
Rongeurs	36 – 40
Cutters	41 – 48
Other Bone Instruments	49 – 50
Curettes & Chisels	51
Knives & Scalpels	52 – 63



Forceps	65 – 97
Dumont	65 – 74
Fine	75 – 85
Moria	78 – 79, 82
S&T	80, 82
Standard	86 – 97
Hemostats	98 – 103



Probes & Hooks	105 – 109
Spatulae	108 – 112
Hippocampal Tools & Spoons	112 – 113
Pins & Holders	114 – 115
Wound Closure	116 – 127
Needle Holders & Suture	116 – 124
Staplers, Clips & Applicators	125 – 127
Retractors	128 – 135
Vascular Instruments	136 – 145
Clamps & Occluders	136 – 141
Dilation & Cannulation	142 – 145
Ligation Aids	143



Animal Accessories	147 – 152
Feeding Needles	147 – 148
Animal Identification	149 – 152
Instrument Care & Accessories	153 – 166
Instrument Care	153 – 156
Sterilization & Storage	157 – 166
Surgical Accessories	167 – 170
Drill Accessories	167
Cauterizers	168 – 169
Accessories	170
Laboratory Accessories	171 – 182
Tools	171 – 174
Magnifiers & Lens Paper	175 – 183



Student Instruments	186 – 207
Quality instruments with the student in mind	
Scissors	186 – 191
Cutter	191
Scalpel Handles	192
Forceps	193 – 198
Fine Forceps	193 – 195
Standard Forceps	196 – 198
Hemostats	199 – 202
Artery Clamps	203 – 205
Pin & Needle Holders	206
Retractors, Vessel Dilator & Clamps	207

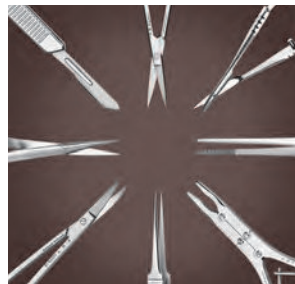

Reference Pages	209 – 228
Worldwide Locations	209
Scissors Test	210
Features and Alloys	211
Maintenance and Care	212 – 214
Quality Control	215
Selection	216
Dumont	217
Numerical and Alphabetical Indexes	218 – 227
Additional Information	228



Scissors, Bone Instruments, Knives & Scalpels

Spring Scissors	Pages	3 – 14
Fine Scissors	Pages	15 – 28
Surgical Scissors	Pages	29 – 35
Bone Instruments	Pages	36 – 51
Knives & Scalpels	Pages	52 – 63



Micro Vannas

These Vannas-style spring scissors have the smallest blades ever produced. They are ideal where space is restricted and where absolute precision is demanded.



**FST
HAND
CRAFTED**

For more information
see page 38.



300%



Straight
Sharp/Sharp

8 cm
Cutting edge: 2 mm
Tip Ø: 0.05 mm

No. 15000-03



Curved
Sharp/Sharp

8 cm
Cutting edge: 2 mm
Tip Ø: 0.05 mm

No. 15000-04

Micro Vannas

The short taper is ideal for small, precise cuts.



15000-08



**FST
HAND
CRAFTED**

For more information
see page 38.



300%



Straight
Sharp/Sharp

8 cm
Cutting edge: 2.5 mm
Tip Ø: 0.05 mm

No. 15000-08



Curved
Sharp/Sharp

8 cm
Cutting edge: 2.5 mm
Tip Ø: 0.05 mm

No. 15001-08



Angled to side
Sharp/Sharp

8 cm
Cutting edge: 2.5 mm
Tip Ø: 0.05 mm

No. 15002-08

Micro Vannas

The long taper is ideal for cutting vessel walls or when a longer cutting edge is needed.



15000-00



**FST
HAND
CRAFTED**

For more information
see page 38.



300%



Straight
Sharp/Sharp

8 cm
Cutting edge: 3 mm
Tip Ø: 0.05 mm

No. 15000-00



Curved
Sharp/Sharp

8 cm
Cutting edge: 3 mm
Tip Ø: 0.05 mm

No. 15000-10

Vannas



**FST
HAND
CRAFTED**

For more information
see page 38.



Straight
Sharp/Sharp

10.5 cm
Cutting edge: 4 mm
Tip Ø: 0.15 mm

No. 15018-10



Curved
Sharp/Sharp

10.5 cm
Cutting edge: 4 mm
Tip Ø: 0.15 mm

No. 15019-10

Vannas-Tübingen



15003-08



**FST
HAND
CRAFTED**

For more information
see page 38.



Straight
Sharp/Sharp

8.5 cm
Cutting edge: 5 mm
Tip Ø: 0.075 mm

No. 15003-08



Angled to side
Sharp/Sharp

8.5 cm
Cutting edge: 5 mm
Tip Ø: 0.075 mm

No. 15008-08



Curved
Sharp/Sharp

8.5 cm
Cutting edge: 5 mm
Tip Ø: 0.075 mm

No. 15004-08



Angled up
Sharp/Sharp

9.5 cm
Cutting edge: 5 mm
Tip Ø: 0.075 mm

No. 15005-08

Vannas Scissors with Microserrations

Microserrated to minimize slippage.



For more information see page 38.



Miniature Vannas

Hand finished under high magnification, these tips are especially useful when incising vessel walls for catheter insertion.



Straight
Sharp/Sharp

8.5 cm
Cutting edge: 5 mm
Tip Ø: 0.1 mm

No. 15070-08



Straight
Sharp/Sharp

8.5 cm
Cutting edge: 7 mm
Tip Ø: 0.1 mm

No. 15007-08



Curved
Sharp/Sharp

8.5 cm
Cutting edge: 5 mm
Tip Ø: 0.1 mm

No. 15071-08

Moria 9600



Straight
Sharp/Sharp

8 cm
Cutting edge: 5 mm
Tip Ø: 0.1 mm

No. 15396-00

Moria 9601



Curved
Sharp/Sharp

8 cm
Cutting edge: 5 mm
Tip Ø: 0.1 mm

No. 15396-01

Titanium Vannas

TITANIUM

For more information see page 211.



**FST
HAND
CRAFTED**

For more information see page 38.



Straight
Sharp/Sharp

9.5 cm
Cutting edge: 5 mm
Tip Ø: 0.3 mm

No. 15610-08



Curved
Sharp/Sharp

9.5 cm
5 mm
Tip Ø: 0.3 mm

No. 15615-08



Angled up
Sharp/Sharp

9.5 cm
5 mm
Tip Ø: 0.3 mm

No. 15617-08

Cohan-Vannas

Long cutting blades for a more controlled cut.



**FST
HAND
CRAFTED**

For more information see page 38.



Straight
Sharp/Sharp

6 cm
Cutting edge: 6 mm
Tip Ø: 0.1 mm

No. 15000-02



Curved
Sharp/Sharp

6 cm
6 mm
Tip Ø: 0.1 mm

No. 15000-01

Straight
Blunt/Blunt

6 cm
6 mm
Tip Ø: 0.15 mm

No. 15000-12

Curved
Blunt/Blunt

6 cm
6 mm
Tip Ø: 0.15 mm

No. 15000-11

ToughCut® Spring Scissors

**TOUGH
CUT**

For more information see page 211.



**FST
HAND
CRAFTED**

For more information see page 38.



Straight
Sharp/Sharp

12.5 cm
6 mm
Tip Ø: 0.3 mm

No. 15124-12



Curved
Sharp/Sharp

12.5 cm
6 mm
Tip Ø: 0.3 mm

No. 15123-12

Round Handled Vannas

Round handles allow easy fingertip adjustments.



For more information see page 38.



Straight
Sharp/Sharp

12.5 cm
Cutting edge: 6 mm
Tip Ø: 0.075 mm

No. 15400-12



Curved
Sharp/Sharp

12.5 cm
Cutting edge: 6 mm
Tip Ø: 0.075 mm

No. 15401-12



For more information see page 38.



Straight
Sharp/Sharp

14 cm
Cutting edge: 6 mm
Tip Ø: 0.15 mm

No. 15020-15



Curved
Sharp/Sharp

14 cm
Cutting edge: 6 mm
Tip Ø: 0.15 mm

No. 15021-15



For more information about our ceramic instruments please visit page 211.



For more information see page 38.



Straight
Sharp/Sharp

10 cm
Cutting edge: 7 mm
Tip Ø: 0.1 mm

No. 15750-11



Curved
Sharp/Sharp

10 cm
Cutting edge: 7 mm
Tip Ø: 0.1 mm

No. 15751-11

Vannas-Wolff



Moria MC52



Straight
Sharp/Sharp

10 cm

Cutting edge: 7 mm

Tip Ø: 0.15 mm

No. 15370-52

Moria MC50



Curved
Sharp/Sharp

10 cm

Cutting edge: 7 mm

Tip Ø: 0.15 mm

No. 15370-50

Vannas

Ultra long cutting edge
without sacrificing tip width.



**FST
HAND
CRAFTED**

For more information
see page 38.



Straight
Sharp/Sharp

8.5 cm

Cutting edge: 8 mm

Tip Ø: 0.1 mm

No. 15009-08

Castroviejo



**FST
HAND
CRAFTED**

For more information
see page 38.



Angled to side
Sharp/Sharp

10 cm

Cutting edge: 10 mm

Tip Ø: 0.125 mm

No. 15006-09

Castroviejo with Ball Tip

Same as No. 15006-09 but with a ball tip to prevent piercing of underlying tissue.



For more information see page 38.

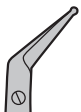

Angled to side
Sharp/Sharp

9 cm
Cutting edge: 8 mm
Tip Ø: 1.3 mm Ball

No. 15033-09

Spring Scissors



For more information see page 38.



Straight
Sharp/Sharp

10 cm
Cutting edge: 8 mm
Tip Ø: 0.15 mm

No. 15024-10



Straight
Blunt/Blunt

10 cm
Cutting edge: 8 mm
Tip Ø: 0.3 mm

No. 15025-10



Curved
Sharp/Sharp

10 cm
Cutting edge: 8 mm
Tip Ø: 0.15 mm

No. 15023-10

Dowell



For more information see page 38.



Straight
Sharp/Sharp

11.5 cm
Cutting edge: 10 mm
Tip Ø: 0.1 mm

No. 15040-11



Angled up
Sharp/Sharp

11.5 cm
Cutting edge: 10 mm
Tip Ø: 0.1 mm

No. 15042-11

Noyes



For more information see page 38.



Straight
Sharp/Sharp

12 cm
Cutting edge: 14 mm
Tip Ø: 0.2 mm

No. 15012-12



Curved
Sharp/Sharp

12 cm
Cutting edge: 14 mm
Tip Ø: 0.2 mm

No. 15011-12

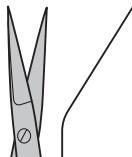

Angled up
Sharp/Sharp

12 cm
Cutting edge: 14 mm
Tip Ø: 0.2 mm

No. 15013-12

Tungsten Carbide Noyes

Tungsten carbide cutting edges provide long lasting sharpness.



For more information see page 211.



For more information see page 38.



Straight
Sharp/Sharp

12 cm
Cutting edge: 14 mm
Tip Ø: 0.275 mm

No. 15514-12

Castroviejo



For more information see page 38.

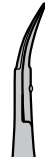
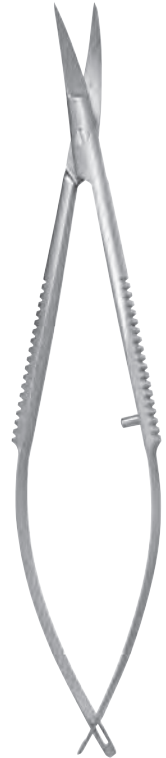

Sharply curved
Sharp/Sharp

10 cm
Cutting edge: 10 mm
Tip Ø: 0.2 mm

No. 15017-10

Ceramic Coated Titanium Castroviejo



For more information see page 38.



For more information see page 211.



For more information about our ceramic instruments please visit page 211.



Straight
Sharp/Sharp

11 cm
Cutting edge: 5 mm
Tip Ø: 0.2 mm

No. 15650-11



Curved
Sharp/Sharp

11 cm
Cutting edge: 5 mm
Tip Ø: 0.2 mm

No. 15651-11

Westcott



For more information see page 38.



Slightly curved
Sharp/Sharp

11 cm
Cutting edge: 15 mm
Tip Ø: 0.25 mm

No. 15015-11

Fine Angled Spring Scissors

These spring scissors aid in cutting tissues from various angles.



For more information see page 38.



Angled up
Sharp/Sharp

9.5 cm
Cutting edge: 2 mm
Tip Ø: 0.1 mm

No. 15010-09



Angled up
Sharp/Sharp

10 cm
Cutting edge: 4 mm
Tip Ø: 0.125 mm

No. 15010-10

Trident II

A re-release of a popular spring scissors now with a new innovative design for a better feel.



Straight
Sharp/Sharp

8 cm
Cutting edge: 8 mm
Tip Ø: 0.2 mm

No. 15110-08



Angled to side
Sharp/Sharp

8 cm
Cutting edge: 8 mm
Tip Ø: 0.2 mm

No. 15111-08

Pascheff-Wolff

Very delicate blades.



Moria MC19/B



Angled up
Sharp/Sharp

10.5 cm
Cutting edge: 3 mm
Tip Ø: 0.15 mm

No. 15371-92

Long Handle Spring Scissors



Straight
Sharp/Sharp

18.5 cm
Cutting edge: 5 mm
Tip Ø: 0.2 mm

No. 15028-18



Curved
Sharp/Sharp

18.5 cm
Cutting edge: 5 mm
Tip Ø: 0.2 mm

No. 15027-18

Micro Scissors

With microserrations to minimize slippage.



For more information see page 38.



300%

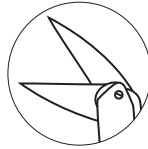

300%

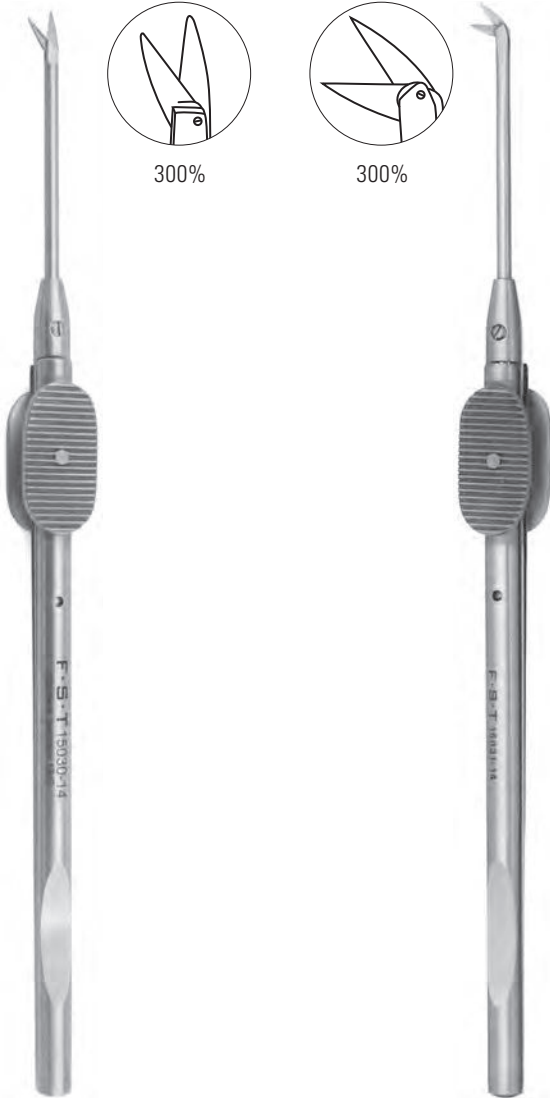

Straight
Sharp/Sharp

14.5 cm
Cutting edge: 2.5 mm
Tip Ø: 0.175 mm

No. 15030-14



Angled to side
Sharp/Sharp

14.5 cm
Cutting edge: 2.5 mm
Tip Ø: 0.175 mm

No. 15031-14

Micro Scissors

The finest blades on spring scissors. Designed for ophthalmic surgery (vitrectomy). The spring handles are made of ribbed plastic to ensure a solid grip. **Autoclavable.**



For more information see page 38.

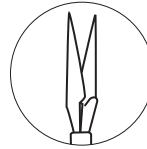

300%



300%



Straight
Sharp/Sharp

14 cm
Cutting edge: 2.2 mm
Tip Ø: 0.15 mm

No. 15036-14



Angled 90°
Sharp/Sharp

14 cm
Cutting edge: 1 mm
Tip Ø: 0.1 mm

No. 15037-14

Ultra Fine Clipper Scissors II

For microscopic dissections of soft and mucous tissue. The minute fineness of the blades allows clear visualization of the tissue being dissected.



Uses:

- Removing sheath of ganglia to access neurons in aplysia.
- Cutting single nerve axons in aplysia, mollusk and snail.
- Stripping fascia off arteries and muscles.
- Ultra fine brain tissue dissection.
- Cutting of minute fiber optic strands.



Straight
Sharp/Sharp

10 cm
Cutting edge: 1.5–2 mm
Tip Ø: 0.05–0.08 mm
Blade shape: Triangular
Blade thickness: 0.1 mm

No. 15300-00

Biemer Scissors

These scissors are designed to securely cut vessels without slipping.



Straight
Blunt/Blunt

8.5 cm
Cutting edge: 4 mm
Tip Ø: 2 mm

No. 15032-08



Straight
Blunt/Blunt

13 cm
Cutting edge: 2 mm
Tip Ø: 2 mm

No. 15032-13

Extra Fine Bonn

Our finest iris scissors, best suited for microdissection under high magnification.

MOST POPULAR
14084-08
14085-08



Straight
Sharp/Sharp

8.5 cm
Cutting edge: 10 mm

No. 14084-08



Curved
Sharp/Sharp

8.5 cm
Cutting edge: 10 mm

No. 14085-08



Straight
Sharp/Blunt

8.5 cm
Cutting edge: 10 mm

No. 14083-08

Bonn

Highly polished.



Straight
Sharp/Sharp

9 cm
Cutting edge: 10 mm

No. 14184-09



Curved
Sharp/Sharp

9 cm
Cutting edge: 10 mm

No. 14185-09

ToughCut® Bonn-Strabismus

A fusion of two light and delicate iris scissors with ToughCut cutting edges.

TOUGH CUT
For more information see page 211.



Straight
Blunt/Blunt

9 cm
Cutting edge: 10 mm

No. 14084-09



Curved
Blunt/Blunt

9 cm
Cutting edge: 10 mm

No. 14085-09

Hardened Fine Iris Scissors

These scissors have an anti-reflective finish to reduce glare.

MOST POPULAR
14090-09



Straight
Sharp/Sharp

9 cm
Cutting edge: 16 mm

No. 14090-09



Curved
Sharp/Sharp

9 cm
Cutting edge: 16 mm

No. 14091-09

11 cm
Cutting edge: 16 mm

No. 14090-11

11 cm
Cutting edge: 16 mm

No. 14091-11

Fine Iris Scissors

Made from Martensitic stainless steel, combined with Molybdenum and Vanadium.



Straight
Sharp/Sharp

10.5 cm
Cutting edge: 16 mm

No. 14094-11



Curved
Sharp/Sharp

10.5 cm
Cutting edge: 16 mm

No. 14095-11

Iris Scissors

Delicate pattern.

MOST POPULAR

14060-11



Straight
Sharp/Sharp

9 cm
Cutting edge: 16 mm

No. 14060-09



Curved
Sharp/Sharp

9 cm
Cutting edge: 16 mm

No. 14061-09

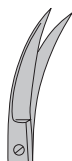

Curved to side
Sharp/Sharp

9 cm
Cutting edge: 16 mm

No. 14062-09

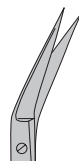

Angled to side
Sharp/Sharp

9 cm
Cutting edge: 16 mm

No. 14063-09

10.5 cm
Cutting edge: 16 mm

No. 14060-10

10.5 cm
Cutting edge: 16 mm

No. 14061-10

10.5 cm
Cutting edge: 16 mm

No. 14062-10

11.5 cm
Cutting edge: 16 mm

No. 14063-11

11.5 cm
Cutting edge: 18 mm

No. 14060-11

11.5 cm
Cutting edge: 18 mm

No. 14061-11

Left Handed Iris Scissors

LEFT HANDED



Straight
Sharp/Sharp

10.5 cm
Cutting edge: 18 mm

No. 14160-10



Curved
Sharp/Sharp

10.5 cm
Cutting edge: 18 mm

No. 14161-10

Moria Iris Scissors



Moria 4877



Straight
Sharp/Sharp

12.5 cm
Cutting edge: 14 mm

No. 14370-22

Moria 4878



Shallow curve
Sharp/Sharp

10.5 cm
Cutting edge: 14 mm

No. 14370-23

Extra Narrow Iris Scissors

Extra narrow, delicate pattern. Very slim blades with gentle cutting action.



Side-view showing
extra narrow pattern

Straight
Sharp/Sharp

10.5 cm
Cutting edge: 16 mm

No. 14088-10

Large Loops Scissors



Straight
Sharp/Sharp

10 cm
Cutting edge: 16 mm

No. 14040-10



Curved
Sharp/Sharp

10 cm
Cutting edge: 16 mm

No. 14041-10

Wagner



Straight
Sharp/Sharp

12 cm
Cutting edge: 20 mm

No. 14068-12



Curved
Sharp/Sharp

12 cm
Cutting edge: 20 mm

No. 14069-12



Straight
Sharp/Sharp

12 cm
Cutting edge: 20 mm

No. 14070-12



Curved
Sharp/Sharp

12 cm
Cutting edge: 20 mm

No. 14071-12

ToughCut®

MOST POPULAR

14058-09
14058-11

TOUGH CUT

For more information
see page 211.



Straight
Sharp/Sharp

9 cm
Cutting edge: 16 mm

No. 14058-09

11.5 cm
Cutting edge: 16 mm

No. 14058-11



Curved
Sharp/Sharp

9 cm
Cutting edge: 16 mm

No. 14059-09

11.5 cm
Cutting edge: 16 mm

No. 14059-11

Tungsten Carbide

MOST POPULAR

14568-09
14568-12

TUNGSTEN CARBIDE

For more information
see page 211.



Straight
Sharp/Sharp

9 cm
Cutting edge: 16 mm

No. 14568-09

11.5 cm
Cutting edge: 16 mm

No. 14568-12



Curved
Sharp/Sharp

9 cm
Cutting edge: 16 mm

No. 14569-09

11.5 cm
Cutting edge: 16 mm

No. 14569-12

ToughCut® and Tungsten Carbide



For more information see page 211.



Straight
Sharp/Sharp

9 cm
Cutting edge: 16 mm

No. 14558-09

11.5 cm
Cutting edge: 16 mm

No. 14558-11



Curved
Sharp/Sharp

9 cm
Cutting edge: 16 mm

No. 14559-09

11.5 cm
Cutting edge: 16 mm

No. 14559-11

CeramaCut®

These ceramic-coated scissors are the cleanest cutting, longest lasting scissors ever produced. Utilizing the unique properties of a ceramic coating, they will last six times longer than tungsten carbide instruments and cut even better than ToughCut® scissors. The black, corrosion-resistant coating has a non-glare finish.



For more information see page 211.



Straight
Sharp/Sharp

9 cm
Cutting edge: 16 mm

No. 14958-09

11.5 cm
Cutting edge: 16 mm

No. 14958-11



Curved
Sharp/Sharp

9 cm
Cutting edge: 16 mm

No. 14959-09

11.5 cm
Cutting edge: 16 mm

No. 14959-11

Fine Scissors

Lexer-Baby

SCISSORS



Straight
Sharp/Blunt

Curved
Sharp/Blunt

10 cm
Cutting edge: 17 mm

10 cm
Cutting edge: 17 mm

No. 14028-10

No. 14029-10



Straight
Blunt/Blunt

Curved
Blunt/Blunt

10 cm
Cutting edge: 16 mm

10 cm
Cutting edge: 16 mm

No. 14078-10

No. 14079-10

Strabismus

Tungsten Carbide Strabismus



**TUNGSTEN
CARBIDE**

For more information
see page 211.



Straight
Blunt/Blunt

9 cm
Cutting edge: 13 mm

No. 14074-09

11.5 cm
Cutting edge: 17 mm

No. 14074-11



Curved
Blunt/Blunt

9 cm
Cutting edge: 13 mm

No. 14075-09

11.5 cm
Cutting edge: 17 mm

No. 14075-11



Straight
Blunt/Blunt

9 cm
Cutting edge: 13 mm

No. 14574-09

11 cm
Cutting edge: 18 mm

No. 14574-11



Curved
Blunt/Blunt

9 cm
Cutting edge: 13 mm

No. 14575-09

11 cm
Cutting edge: 18 mm

No. 14575-11

Walton



Slightly curved
Sharp/Sharp

9.5 cm
Cutting edge: 10 mm

No. 14077-09



Slightly curved
Sharp/Sharp

10.5 cm
Cutting edge: 12 mm

No. 14077-10

Stevens Tenotomy



Straight
Sharp/Sharp

11 cm
Cutting edge: 13 mm

No. 14064-11



Straight
Blunt/Blunt

11 cm
Cutting edge: 13 mm

No. 14066-11



Curved
Sharp/Sharp

11 cm
Cutting edge: 13 mm

No. 14065-11



Curved
Blunt/Blunt

11 cm
Cutting edge: 13 mm

No. 14067-11

LaGrange

One edge is serrated to minimize slippage of tissue during cutting. Curved handle helps when cutting from an awkward angle.



Side View



Curved
Sharp/Sharp

11.5 cm
Cutting edge: 11 mm

No. 14173-12

Shea

Transplant scissors with light and delicate pattern.



Curved
Blunt/Blunt

12 cm
Cutting edge: 13 mm

No. 14105-12

Dissector Scissors

Slim blades for cutting tissue.

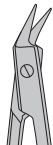

Angled to side
Sharp/Sharp

10 cm
Cutting edge: 5 mm

No. 14081-09

Dissector Scissors

Similar to 14081-09, but with stronger blades for cutting fine bone.

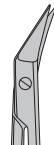

Angled to side
Sharp/Sharp

10.5 cm
Cutting edge: 8 mm

No. 14082-09

Spencer Ligature

Used for cutting stitches or suture.



Straight
Sharp/Sharp

9 cm
Cutting edge: 13 mm

No. 14076-09

Bonn Artery

Iris scissors with one ball tip to prevent piercing of underlying tissue.



Straight
Sharp/Ball tip

9 cm
Cutting edge: 8 mm
Tip Ø: 1.5 mm Ball

No. 14086-09



Straight
Sharp/Ball tip

11.5 cm
Cutting edge: 15 mm
Tip Ø: 1.5 mm Ball

No. 14080-11

Tissue Separating Scissors



Straight
Blunt/Blunt

11.5 cm
Cutting edge: 15 mm

No. 14072-10

Graefe

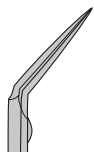

Sharply angled up
Sharp/Sharp

10.5 cm
Cutting edge: 9 mm

No. 14037-10

Adjustable Loops Fine Scissors

The finger loops can be enlarged to fit almost any size.



Straight
Sharp/Sharp

9.5 cm
Cutting edge: 8 mm

No. 14106-09



Straight
Blunt/Blunt

9.5 cm
Cutting edge: 8 mm

No. 14108-09

Kaye

These scissors have semi-sharp outer edges to better facilitate dissection.



Slightly curved
Blunt/Blunt

10.5 cm
Cutting edge: 14 mm

No. 14171-10

Standard Pattern

MOST POPULAR

14001-12 – 14001-18

LEFT HANDED 

14008-14



Our standard surgical scissors are recognized for these important features:

- Excellent feel and handling capability.
- Overall execution that marks them as fine examples of German craftsmanship.



Length (cm)	Cutting edge (mm)	Straight Sharp/Sharp	Price	Straight Sharp/Blunt	Price	Straight Blunt/Blunt	Price
12	26	No. 14002-12		No. 14001-12		No. 14000-12	
13	26	No. 14002-13		No. 14001-13		No. 14000-13	
14.5	29	No. 14002-14		No. 14001-14		No. 14000-14	
16.5	33	No. 14002-16		No. 14001-16		No. 14000-16	
18.5	36			No. 14001-18		No. 14000-18	
20	39					No. 14000-20	

Length (cm)	Cutting edge (mm)	Straight Sharp/Blunt	Price
14.5	29	No. 14008-14	



Length (cm)	Cutting edge (mm)	Curved Sharp/Sharp	Price	Curved Sharp/Blunt	Price	Curved Blunt/Blunt	Price
12	26	No. 14005-12		No. 14004-12		No. 14003-12	
13	26	No. 14005-13		No. 14004-13		No. 14003-13	
14.5	29	No. 14005-14		No. 14004-14		No. 14003-14	
16.5	33	No. 14005-16		No. 14004-16		No. 14003-16	
18.5	36			No. 14004-18		No. 14003-18	
20	39					No. 14003-20	

ToughCut® Standard Pattern



14054-13



For more information see page 211.



80% of actual size

Tungsten Carbide Standard Pattern



For more information see page 211.



80% of actual size

Standard Pattern with Serrations



80% of actual size



Straight Sharp/Blunt
13 cm
Cutting edge: 27 mm
No. 14054-13



Straight Sharp/Blunt
17.5 cm
Cutting edge: 40 mm
No. 14130-17



Straight Sharp/Sharp
14.5 cm
33 mm
No. 14502-14



Straight Sharp/Blunt
14.5 cm
33 mm
No. 14501-14



Curved Sharp/Sharp
14.5 cm
33 mm
No. 14505-14



Curved Sharp/Blunt
14.5 cm
33 mm
No. 14504-14



Straight Sharp/Blunt
14 cm
29 mm
No. 14007-14

Standard Pattern with Large Finger Loops



80% of actual size



Straight
Sharp/Blunt

14.5 cm
Cutting edge: 27 mm

No. 14101-14

Tungsten Carbide Mini-Lister



For more information see page 211.



Angled to side
Blunt/Blunt

9 cm
Cutting edge: 15 mm

No. 14531-09



Lister

Excellent skin cutting scissors. Longer, blunt blade prevents damaging tissue underneath skin without losing the cutting line.



80% of actual size



Angled to side
Blunt/Blunt

14 cm
Cutting edge: 26 mm

No. 14131-14

Metzenbaum Baby

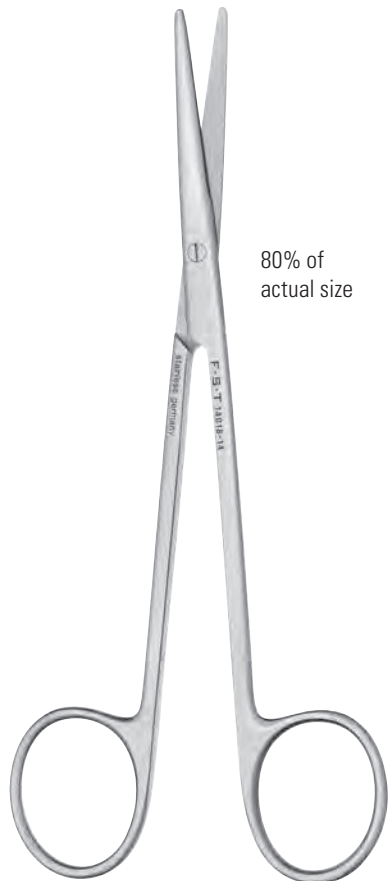

80% of actual size

Tungsten Carbide Metzenbaum Fino

**TUNGSTEN
CARBIDE**

For more information see page 211.



80% of actual size



Straight
Blunt/Blunt

13 cm
Cutting edge: 21 mm

No. 14018-13



Curved
Blunt/Blunt

13 cm
21 mm

No. 14019-13

14.5 cm
Cutting edge: 21 mm

No. 14018-14

14.5 cm
21 mm

No. 14019-14

18 cm
Cutting edge: 23 mm

No. 14018-18

18 cm
23 mm

No. 14019-18



Straight
Blunt/Blunt
Ultra fine tips

14.5 cm
21 mm

No. 14508-15



Straight
Blunt/Blunt

14.5 cm
21 mm

No. 14518-14



Curved
Blunt/Blunt
Ultra fine tips

14.5 cm
21 mm

No. 14509-15



Curved
Blunt/Blunt

14.5 cm
21 mm

No. 14519-14

18 cm
26 mm

No. 14518-18

18 cm
26 mm

No. 14519-18

Metzenbaum

ToughCut® Metzenbaum



For more information see page 211.

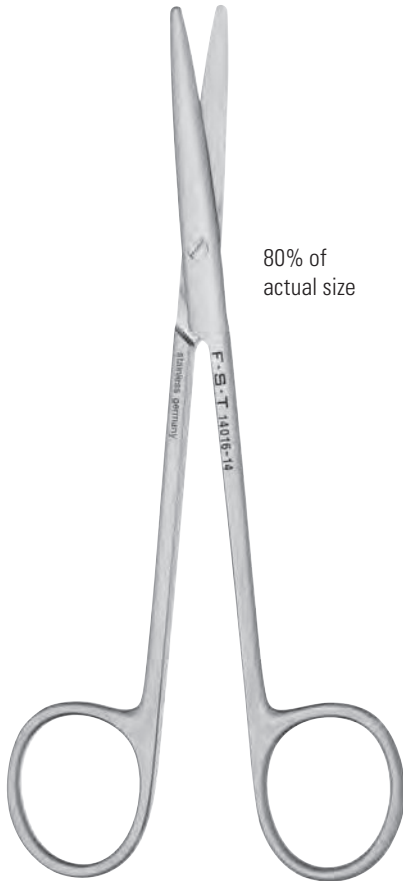

80% of actual size



80% of actual size



Straight
Sharp/Blunt

14.5 cm
Cutting edge: 23 mm

No. 14024-14



Straight
Blunt/Blunt

14.5 cm
Cutting edge: 23 mm

No. 14016-14



Curved
Blunt/Blunt

14.5 cm
Cutting edge: 23 mm

No. 14017-14

18 cm
Cutting edge: 23 mm

No. 14016-18

18 cm
Cutting edge: 23 mm

No. 14017-18



Straight
Blunt/Blunt

14.5 cm
Cutting edge: 17 mm

No. 14116-14



Curved
Blunt/Blunt

14.5 cm
Cutting edge: 17 mm

No. 14117-14

18 cm
Cutting edge: 21 mm

No. 14116-18

18 cm
Cutting edge: 21 mm

No. 14117-18

Mayo

ToughCut® Mayo

Tungsten Carbide Mayo



For more information see page 211.



For more information see page 211.



14512-15 & 14512-17
For more information see page 211.



80% of actual size



80% of actual size



80% of actual size



Straight
Blunt/Blunt

Curved
Blunt/Blunt

15 cm
Cutting edge: 27 mm

15 cm
27 mm

No. 14010-15

No. 14011-15

17 cm
Cutting edge: 33 mm

17 cm
33 mm

No. 14010-17

No. 14011-17



Straight
Blunt/Blunt

Curved
Blunt/Blunt

15 cm
26 mm

15 cm
26 mm

No. 14110-15

No. 14111-15

17 cm
33 mm

17 cm
33 mm

No. 14110-17

No. 14111-17



Straight
Blunt/Blunt

Curved
Blunt/Blunt

Straight
Blunt/Blunt

15 cm
26 mm

15 cm
26 mm

15 cm
26 mm

No. 14510-15

No. 14511-15

No. 14512-15

17 cm
33 mm

17 cm
33 mm

17 cm
33 mm

No. 14510-17

No. 14511-17

No. 14512-17

Mayo-Stille



80% of actual size

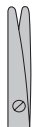

Straight
Blunt/Blunt

15 cm
Cutting edge: 27 mm

No. 14012-15



Curved
Blunt/Blunt

15 cm
Cutting edge: 27 mm

No. 14013-15

17 cm
Cutting edge: 31 mm

No. 14012-17

17 cm
Cutting edge: 31 mm

No. 14013-17

Mayo-Noble



80% of actual size



Straight
Blunt/Blunt

16.5 cm
Cutting edge: 29 mm

No. 14014-17



Curved
Blunt/Blunt

16.5 cm
Cutting edge: 29 mm

No. 14015-17

Decapitation Scissors

Stop guard at tips to prevent slippage.



70% of actual size



Straight
Blunt/Blunt

21 cm
Cutting edge: 47 mm

No. 14200-21

Friedman-Pearson

This popular, fine-tipped rongeur is suited for delicate work. The fine-cupped jaws have been designed with a longer and slimmer approach for better visibility.



**FST
HAND
CRAFTED**

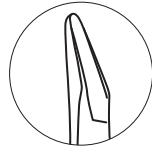

For more information
see page 38.

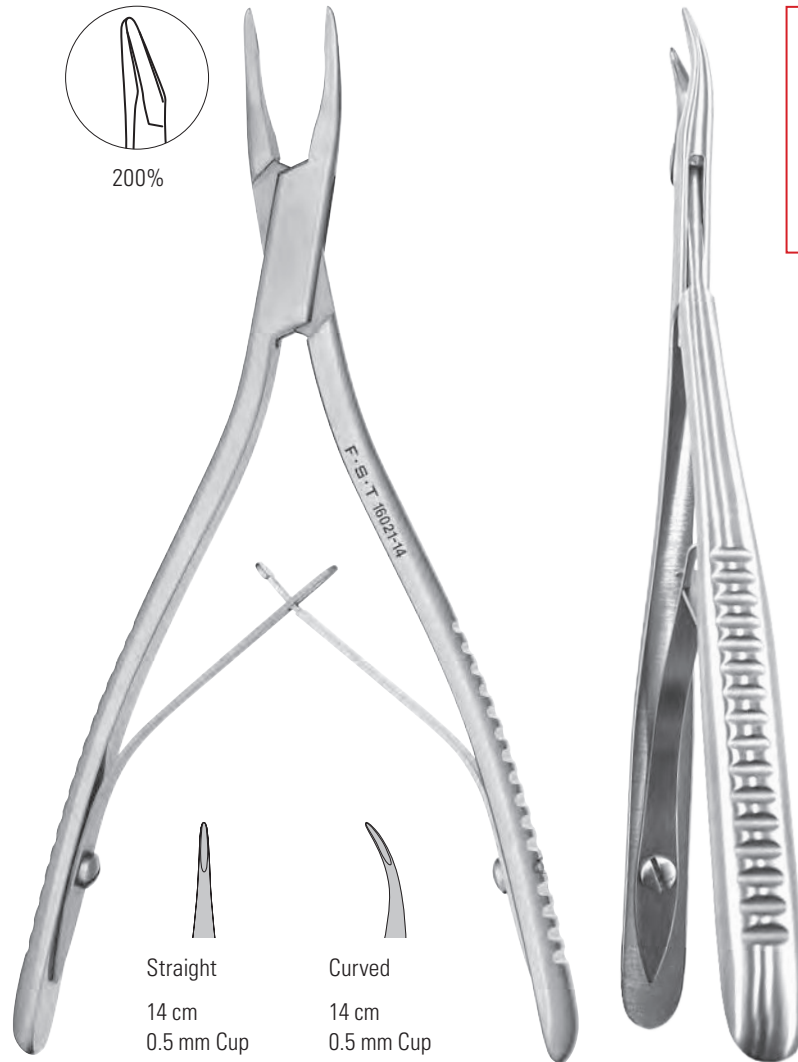

200%



Cautionary note:
The fine rongeur tips shown on this page are extremely fragile. Removal of material with a twisting motion can damage the tips.

	
Straight	Curved
14 cm 0.5 mm Cup	14 cm 0.5 mm Cup
No. 16220-14	No. 16221-14
14 cm 0.7 mm Cup	14 cm 0.7 mm Cup
No. 16120-14	No. 16121-14
14 cm 1 mm Cup	14 cm 1 mm Cup
No. 16020-14	No. 16021-14

Pearson

Provides excellent visibility at dissection site due to its extra long and narrow approach to the fine cutting jaws. Especially suitable for larger hands.



Luer

Cautionary note:
The fine rongeur tips shown on this page are extremely fragile. Removal of material with a twisting motion can damage the tips.



Slightly Curved

17 cm
1.2 mm Cup

No. 16015-17

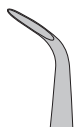

Sharply Curved

17 cm
1.2 mm Cup

No. 16016-17



Curved

15 cm
4 mm Cup

No. 16001-15



Precision that makes a mark.

Our surgical mechanics refine and perfect instruments in FST's very own workshop, this is a step that only we take in this form. This is essential for the precision and quality of each and every one of our products.

For example, our Friedman-Pearson rongeurs with tip diameters of 0.5 or 0.7 mm, both are unique in the world. Also, our spring scissors have established themselves in the research industry and are second to none in terms of fineness.

The result: a level of quality that makes its mark - and to which we have now dedicated our own. Our new symbol "Hand-Crafted" stands for 100% guaranteed craftsmanship and instruments you can rely on in any situation.



Baby-Beyer

Double-action rongeur with strong jaws helps relieve hand strain.

Beyer

Double-action rongeur with strong jaws helps relieve hand strain.

Diameter of this circle determines cup size.
 Form an imaginary circle that will fit in the very tip of the instrument and measure its diameter.

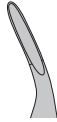

	
Straight	Curved
15 cm	15 cm
2 mm Cup	2 mm Cup
No. 16023-15	No. 16022-15



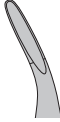

Curved
18 cm
2.5 mm Cup
No. 16002-18

Friedman

Strong and large jaws are ideal for use on the harder, outer regions of the spinal cord. Also can be used to gain access to delicate structures encased in bone.

Lempert

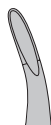
Extra fine jaws.



Curved
13 cm
2.5 mm Cup
No. 16000-14

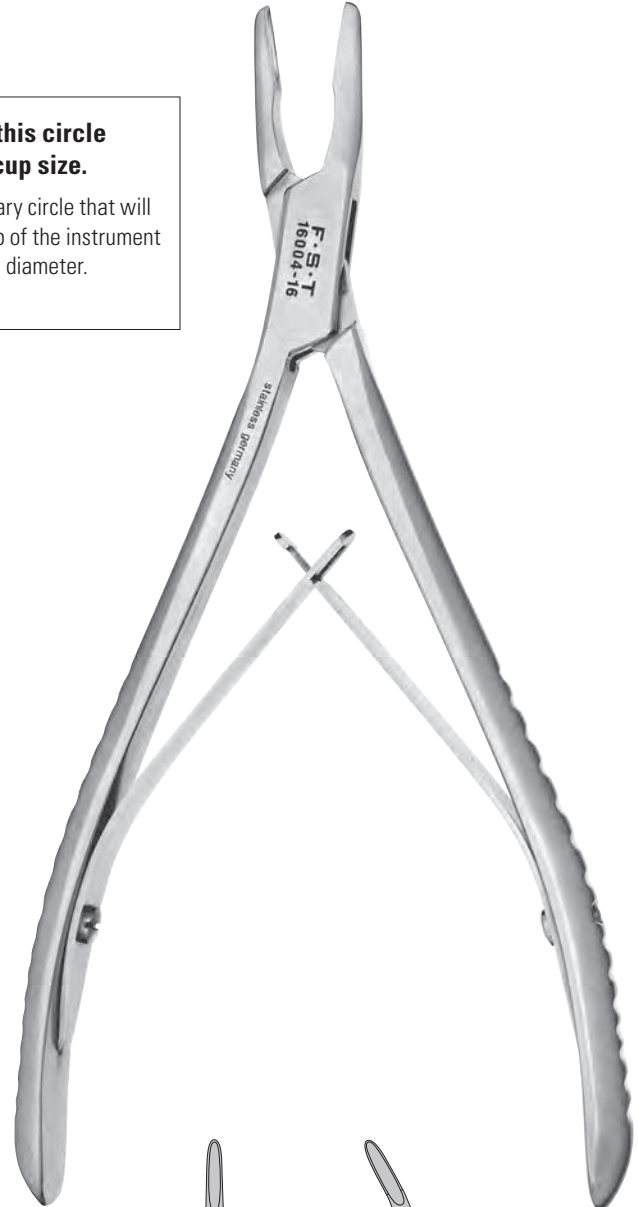
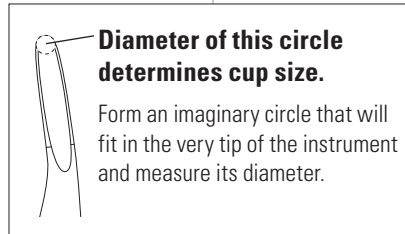

Straight
16 cm
2.5 mm Cup
No. 16004-16



Curved
16 cm
2.5 mm Cup
No. 16005-16

Bone Trimmers



Curved
14 cm
Cutting edge: 8 mm
No. 16109-14

Cartilage Cutter

Round cutting blades for tissue, cartilage and soft bone.



Curved
14 cm
Cutting edge: 9 mm
No. 16107-14

Dumont #15a Bone Cutter

Cutting edge on both outside and inside bevel. Cuts suture, cartilage, bone and steel wire to 0.06 mm, and copper wire to 0.15 mm.

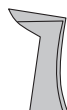

Angled
11.5 cm
Cutting edge: 10 mm
Jaw opening: 2.5 mm
Hard carbon steel
No. 11215-01

Dumont #15a Bone Cutter – Epoxy Coated

Same structure and functionality as Item No. 11215-01 (left), but with an epoxy coating up to the cutting edge for easier care and maintenance.



Angled
11.5 cm
Cutting edge: 6 mm
Jaw opening: 2.5 mm
Epoxy coated carbon steel
No. 11215-02

BONE
INSTRUMENTS

For information on Dumont alloys and tip styles, see page 217.

Tungsten Carbide Bone Cutter

**TUNGSTEN
CARBIDE**

For more information
see page 211.

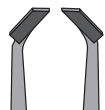

Angled

11.5 cm

Cutting edge: 10 mm

Stainless Steel handle with
Tungsten Carbide Tips

No. 11515-02

Micro Bone Cutter



Angled 25°

13 cm

Cutting edge: 5 mm

Rolling Bearing Steel handle
with TPE Grip

No. 16103-11

Bone Nipper

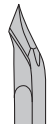

Angled
11 cm
Cutting edge: 5 mm
No. 16102-11

Offset Bone Nipper

Strong jaws for cutting tough cartilage.



Angled
10 cm
Cutting edge: 7 mm
No. 16101-10

Malleus Nipper



Bone Cutting Spring Scissors



Delicate Bone Cutting Spring Scissors

Slim, strong blades for cutting fine bones and tissues.

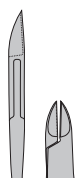

Straight

11 cm
Cutting edge: 9 mm

No. 16140-11

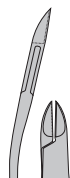

Angled down

11 cm
Cutting edge: 9 mm

No. 16141-11

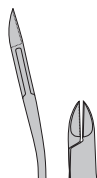

Angled up

11 cm
Cutting edge: 9 mm

No. 16142-11

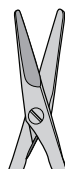

Straight

13 cm
Cutting edge: 12 mm

No. 16144-13



Curved

12 cm
Cutting edge: 12 mm

No. 16143-12

Littauer Bone Cutter

BONE INSTRUMENTS



Straight
11 cm
Cutting edge: 15 mm
No. 16152-11



Straight
12.5 cm
Cutting edge: 17 mm
No. 16152-12



Straight
15 cm
Cutting edge: 19 mm
No. 16152-15

Beebee Bone Scissors

Very strong jaws with sharp points.

MOST POPULAR



Straight
10 cm
Cutting edge: 15 mm
No. 16044-10

Tungsten Carbide Bone Scissors

Strong heavy blades for cutting bone.

TUNGSTEN CARBIDE

SERRATED

For more information see page 211.



Straight
12.5 cm
Cutting edge: 15 mm
No. 16030-12



Straight
16 cm
Cutting edge: 15 mm
No. 16030-16

Boehler

Bone splitting cutter with very fine tips and double action joint to relieve strain on your hand.



Angled up 10°

15 cm

Cutting edge: 18 mm

No. 16130-15

Skull Flap Cutter

One tip has a flat and narrow platform which fits between dura and skull. Other tip has sharp cutting edge. The double action joint relieves strain on your hand.



Angled up 15°

14 cm

Cutting edge: 10 mm

No. 16050-15

Cleveland Cutter



Slightly angled
15 cm
Cutting edge: 14 mm
No. 16106-14

17 cm
Cutting edge: 15 mm
No. 16105-16

Liston

Gross anatomy bone cutter.



Straight
14 cm
Cutting edge: 20 mm
No. 16104-14

20 cm
Cutting edge: 30 mm
No. 16104-19

Bone Pliers

To peel back skull flaps.

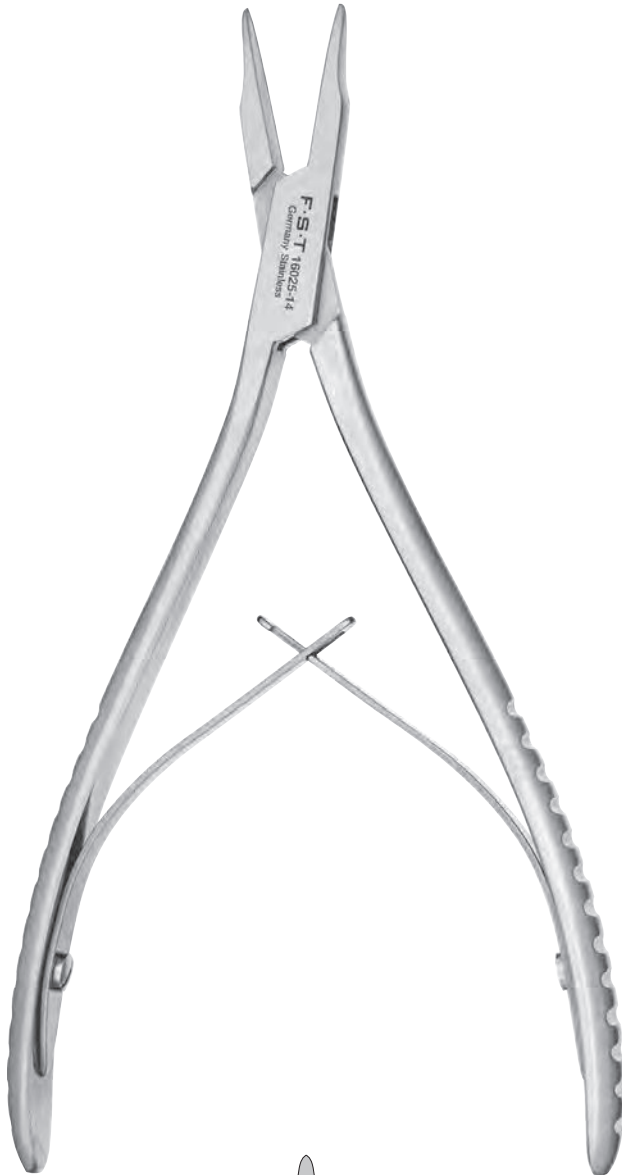

Straight
15.5 cm
Flat surface
No. 16025-14

Bone Shears



60% of
actual size

Curved
24 cm
Cutting edge: 6.5 cm
No. 16150-24

Bone Forceps

Strong cross-serrated tips for bone crushing and removal.



Angled
11.5 cm
Tip Ø: 1 mm
Cross serrated
No. 16060-11

Miniature Self-Tapping Bone Screws

Used extensively to anchor dental cement to bone, these self-tapping screws have superior holding strength over ordinary machine screws. Stainless steel with fillister flat head.



4 mm
Shaft diameter: 0.86 mm
Pkg. of 100 screws
No. 19010-10

4.8 mm
Shaft diameter: 1.19 mm
Pkg. of 100 screws
No. 19010-00

Pkg. of 10 screws
No. 19010-11

Pkg. of 10 screws
No. 19010-01

For pre-drilling use our 0.7 mm burrs, see page 167.

For pre-drilling use our 0.9 mm burrs, see page 167.

Bone Wax

A beeswax-based compound for bone hemostasis. Soft, kneadable and ready to use.
Sterile.



Box of 12 foil packs (2.5 g each)
No. 19009-00

Micro Curette

Curette tips consist of a scoop with sharp edges and are used for scraping or cleaning. They can also be used for separating and transporting, inoculating plates or transferring small amounts of chemicals.



Delicate Bone Scraper

For scraping tissue without cutting into bone.



Austin Chisel



Dissecting Chisel



Serrations on cutting edge

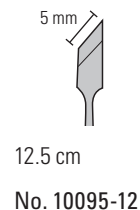
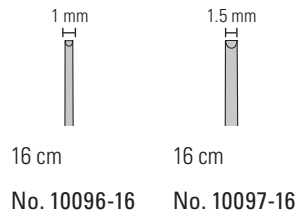
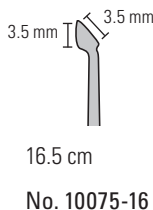
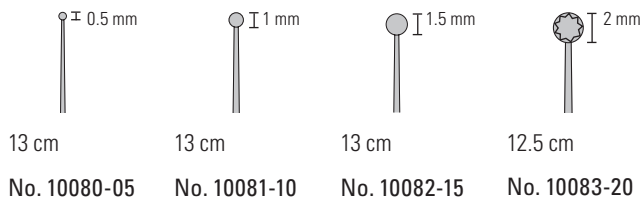

Von Graefe Knife

Used for cutting dura.

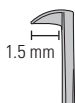

Angled 90°
13 cm
Cutting edge: 1.5 mm
No. 10059-13

Cataract Knife

One of the most popular dissecting knives with a microfine point. The cutting edge is lance shaped to provide the ideal cutting angle.

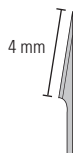

Straight
12.5 cm
Cutting edge: 4 mm
No. 10055-12

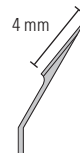

Angled 30°
12.5 cm
Cutting edge: 4 mm
No. 10056-12

Sichel

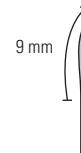

Curved
12 cm
Cutting edge: 9 mm
No. 10073-14

Micro Knife

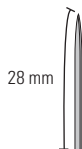

Straight
13 cm
Cutting edge: 28 mm
No. 10370-13

Micro Knife Side Cut

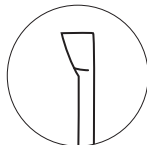

200%

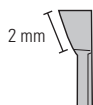

Side blade 20°
15 cm
Cutting edge: 2 mm
No. 10058-15

Circle Knife

Sharp cutting edge around tip.



250%



Angled 90°
16 cm
Cutting edge: 2 mm
No. 10059-15

Gross Anatomy Knives

Handles are made of fiberglass reinforced yellow nylon with a slip resistant surface that allows little chance of bacterial accumulation. The blades are made of German Molybdenum Stainless Steel.



40% of actual size

Dissection knife

28 cm
Cutting edge: 13 cm
No. 10157-13

30 cm
Cutting edge: 15 cm
No. 10157-15

33 cm
Cutting edge: 18 cm
No. 10157-18



40% of actual size

Brain sectioning knife

45 cm
Cutting edge: 30 cm
No. 10152-30

Obsidian Stone Age Scalpels

For applications where extremely fine cuts are required or for studies where trace metals from ordinary scalpel blades cannot be tolerated. These ultra fine cutting edges have been used in human surgical procedures where objectionable scar tissue results from the use of standard scalpels.

The blade is made from obsidian—a type of volcanic glass—which allows a much finer blade than is possible with the conventional steel blade. In some cases this makes the relatively inexpensive obsidian scalpel a suitable substitute for an expensive diamond knife.

Patterned after “stone age” knives which first made their appearance about 18,000 years ago, these modern versions utilize hard wood and plastic dowels for handles. Plastic dowels are made of polyoxymethylene.

Cautionary note:
 Obsidian is a very fragile material. Great care should be taken to not exert any lateral pressure on the blade during cutting. Each blade is hand-fashioned, so sizes, shapes and points will vary. While all the blades will have at least one sharp edge, some will have two.



Wood Dowel
Not autoclavable

Straight
 Approximate blade length: 6 mm
 No. 10110-01



Plastic Dowel
Autoclavable

Straight
 Approximate blade length: 6 mm
 No. 10110-05



Plastic Dowel
Autoclavable

Angled
 Approximate blade length: 6 mm
 No. 10110-07

Ceramic Blades

Advantages:

- Ceramic edge stays sharp 100 times longer than steel edge
- Rust and corrosion free
- Chemical and acid resistant
- Withstands up to 2400°C (4352°F)
- No electrostatic discharge concerns
- No trace metal contamination
- Fully nonmagnetic



Ceramic Blades



45° Cutting Edge
33 x 6 x 0.5 mm
Cutting edge: 4.5 mm
Pkg. of 5 blades
No. 10025-44



45° Cutting Edge
33 x 6 x 0.5 mm
Cutting edge: 2.5 mm
Pkg. of 5 blades
No. 10025-43



23° Cutting Edge
33 x 6 x 0.5 mm
Cutting edge: 14 mm
Pkg. of 5 blades
No. 10025-23



Aluminum Alloyed Handle
12.5 cm
No. 10025-50

45° Cutting Edge
33 x 6 x 0.5 mm
Cutting edge: 8 mm
Pkg. of 5 blades
No. 10025-45

Diamond Knives

This knife has a gem-quality, neutral diamond blade which is honed to the finest cutting edge possible. The blade is made to an ophthalmic surgical standard and is inspected under 400x magnification. The retractable handle aids in care and storage.

Cautionary note:

This blade is extremely fragile and vulnerable to lateral pressure.



Cutting angle: 30°
12 cm
Cutting edge: 1 mm
Tip thickness: 0.15 mm
No. 10100-30



Cutting angle: 45°
12 cm
Cutting edge: 1 mm
Tip thickness: 0.15 mm
No. 10100-45



Grip slides up the handle to protect the tip for safe storage and packing.

Blade Holders and Breakers



11 cm
Jaw width: 4 mm
Flat surface
No. 10052-11



9 cm
Jaw width: 4 mm
Surface with concave and convex jaws
Handle diameter: 5.5 mm
No. 10053-09

13 cm
Jaw width: 4 mm
Surface with concave and convex jaws
Handle diameter: 8 mm
No. 10053-13

Breakable Carbon Steel Blades

These special, high carbon content blades are the only blades that will break cleanly.
Not autoclavable.



Blade thickness: 0.1 mm
Box of 10 blades
No. 10050-00

Create Your Own Blade

With these blade holders/breakers and our special carbon steel blades, No. 10050-00, you can produce microblades in sizes that meet your own individual needs.

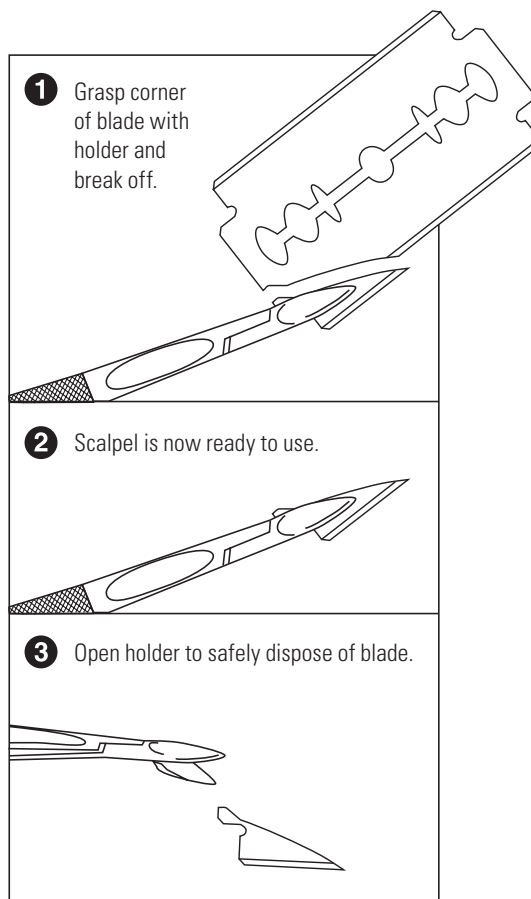

KNIVES & SCALPELS

Carbon Steel Scalpel

Cold forged from carbon steel and sharpened to eliminate tissue distortion and blade drag. 12.5 cm plastic handle with slip-proof grip. **Sterile.**

MOST POPULAR
10316-14
10315-12

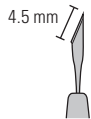

Cutting angle: 22.5°
13.5 cm
Cutting edge: 4.5 mm
Tip thickness: 0.15 mm
No. 10316-14



Cutting angle: 15°
13 cm
Cutting edge: 5 mm
Tip thickness: 0.15 mm
No. 10315-12

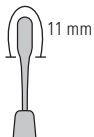

Crescent blade
14 cm
Cutting edge: 11 mm
Tip thickness: 0.20 mm
No. 10317-14



Needle blade
14.5 cm
Cutting edge: 4 mm
Tip thickness: 0.20 mm
No. 10318-14

Interchangeable Carbon Steel Blades

NOT AUTOCLAVABLE



Handle for Interchangeable Blades

9.5 cm
No. 10035-00
12.5 cm
No. 10035-12



Angled blade
Carbon steel
Cutting edge: 10 mm
Pkg. of 5 blades
No. 10035-15



Curved blade
Carbon steel
Cutting edge: 10 mm
Pkg. of 5 blades
No. 10035-20



Small flat blade
Carbon steel
Cutting edge: 1.5 mm
Pkg. of 5 blades
No. 10035-05



Large flat blade
Carbon steel
Cutting edge: 2.75 mm
Pkg. of 5 blades
No. 10035-10



Cane blade
Carbon steel
Cutting edge: 12 mm
Pkg. of 5 blades
No. 10035-25



Arc blade
Carbon steel
Cutting edge: 12 mm
Pkg. of 5 blades
No. 10035-30

Scalpel Handle #4 with Silicone

For heavy, gross anatomy work.
Molded to fit hand.



13.5 cm
No. 10009-13

Standard Scalpel Handle #4 Solid

Especially suitable for large dissections.



13 cm
No. 10004-13

Blades for #4 Scalpel Handle

The alloy used has a high carbon content which provides a longer lasting edge. Blades come individually wrapped. **Non-sterile.**



Box of 100 blades
No. 10020-00



Box of 100 blades
No. 10021-00



Box of 100 blades
No. 10022-00



Box of 100 blades
No. 10023-00

#3 Standard

MOST POPULAR



12 cm
No. 10003-12

#3 Secure

A safety lock holds the blade securely, and allows simple and safe blade attachment and removal.



1 Slide blade onto front pin of the handle.

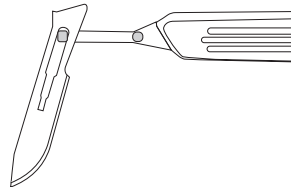

2 Then slide pin to front slot of blade. Rotate blade clockwise and secure blade to back pin on handle.

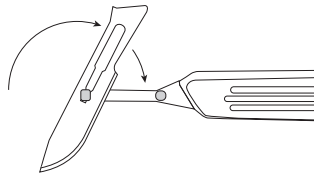

3 Scalpel is ready to use.

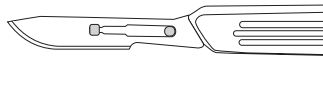

12 cm
No. 10003-13

Blades for #3 and #7 Scalpel Handles

The alloy used has a high carbon content which provides a longer lasting edge. Blades come individually wrapped. **Non-sterile.**

NOT AUTOCLAVABLE



Box of 100 blades
No. 10010-00



Box of 100 blades
No. 10011-00



Box of 100 blades
No. 10012-00



Box of 100 blades
No. 10015-00

Short Scalpel Handle #7



12 cm
No. 10007-12

Standard Scalpel Handle #7



16.5 cm
No. 10007-16

Scalpel Blade Remover

For safe removal of scalpel blades, simply insert scalpel with blade into the Scalpel Blade Remover and press the sides together. This will dislodge the blade from handle and hold the blade securely for release.

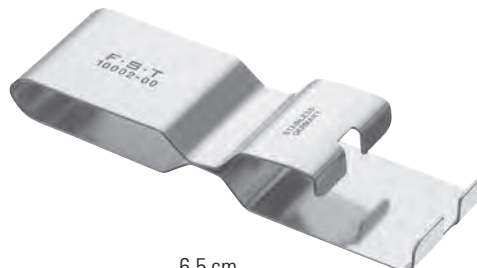

6.5 cm
No. 10002-00

Scalpel Blade Removal and Disposal Box

This plastic device will remove used scalpel blades safely and retain them for safe disposal. Can be used for blades that fit the #3, #4, #7 and Gross Anatomy handles.



7.5 x 5 x 2.5 cm
Capacity approximately 80 blades
Carton of 10 boxes
No. 10002-50

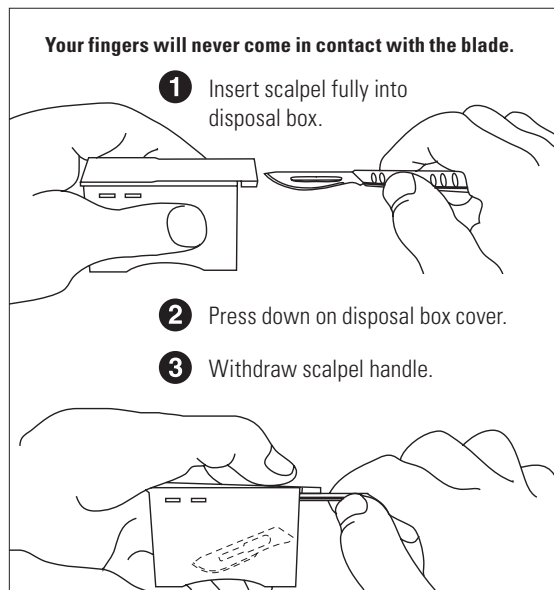

Gross Anatomy Blade and Handle



7.5 cm
Box of 100 blades
No. 10060-00



13 cm
No. 10060-13

Disposable Safety Scalpels

Plastic handle #3 with stainless steel blades. The protective cartridge completely covers the blade for safe, fast, and easy disposal. **Single-use and non-sterile.**



#10 scalpels
Pkg. of 10
No. 10000-10



#11 scalpels
Pkg. of 10
No. 10000-11



#15 scalpels
Pkg. of 10
No. 10000-15



Scalpel shown with safety cartridge closed and locked into place.

Safety Scalpel Handle #3 and Blade Cartridges

The Safety Scalpel Handle #3 is compatible with all Safety Scalpel Blades. The handle is reusable and made of Teflon coated stainless steel which provides a non-stick surface. The Blade Cartridges are color-coded with clear windows for easy identification. The protective cartridge completely covers the blade for safe, fast, and easy disposal. **Handle is reusable and autoclavable. Blades are single-use and non-sterile.**

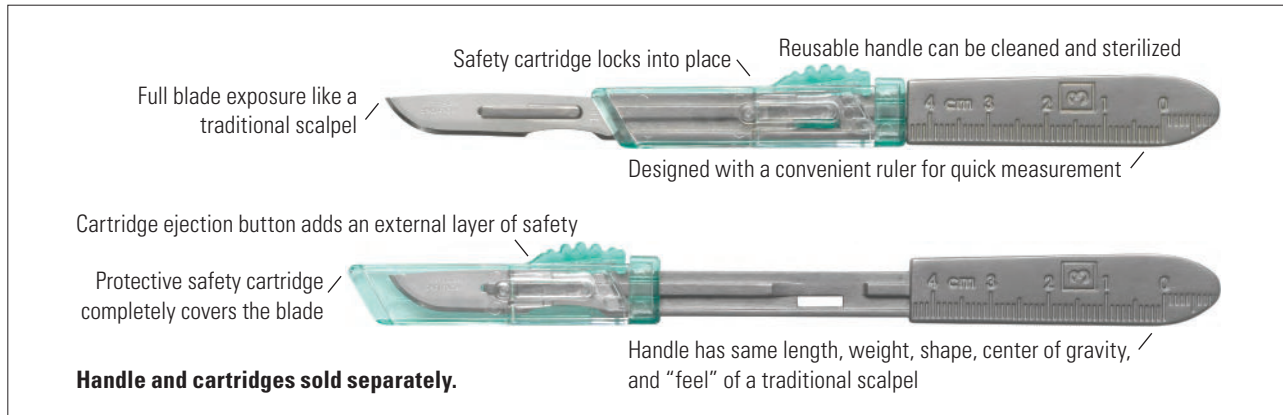

Safety Scalpel Handle #3



12.5 cm
Teflon coated stainless steel
No. 10006-12

Safety Scalpel Blade Cartridges



Safety Scalpel Blade Cartridges shown open and attached to handle.
Handle and cartridges sold separately.

#10 blades	#11 blades	#15 blades
Pkg. of 10	Pkg. of 10	Pkg. of 10
No. 10010-10	No. 10011-10	No. 10015-10



Forceps & Hemostats

Dumont	Pages	65 – 74	<i>See page 217 for alloy and additional information.</i>
Fine	Pages	75 – 85	
Moria	Page	78 – 79, 82	
S&T	Pages	80, 82	
Standard	Pages	86 – 97	
Hemostats	Pages	98 – 103	

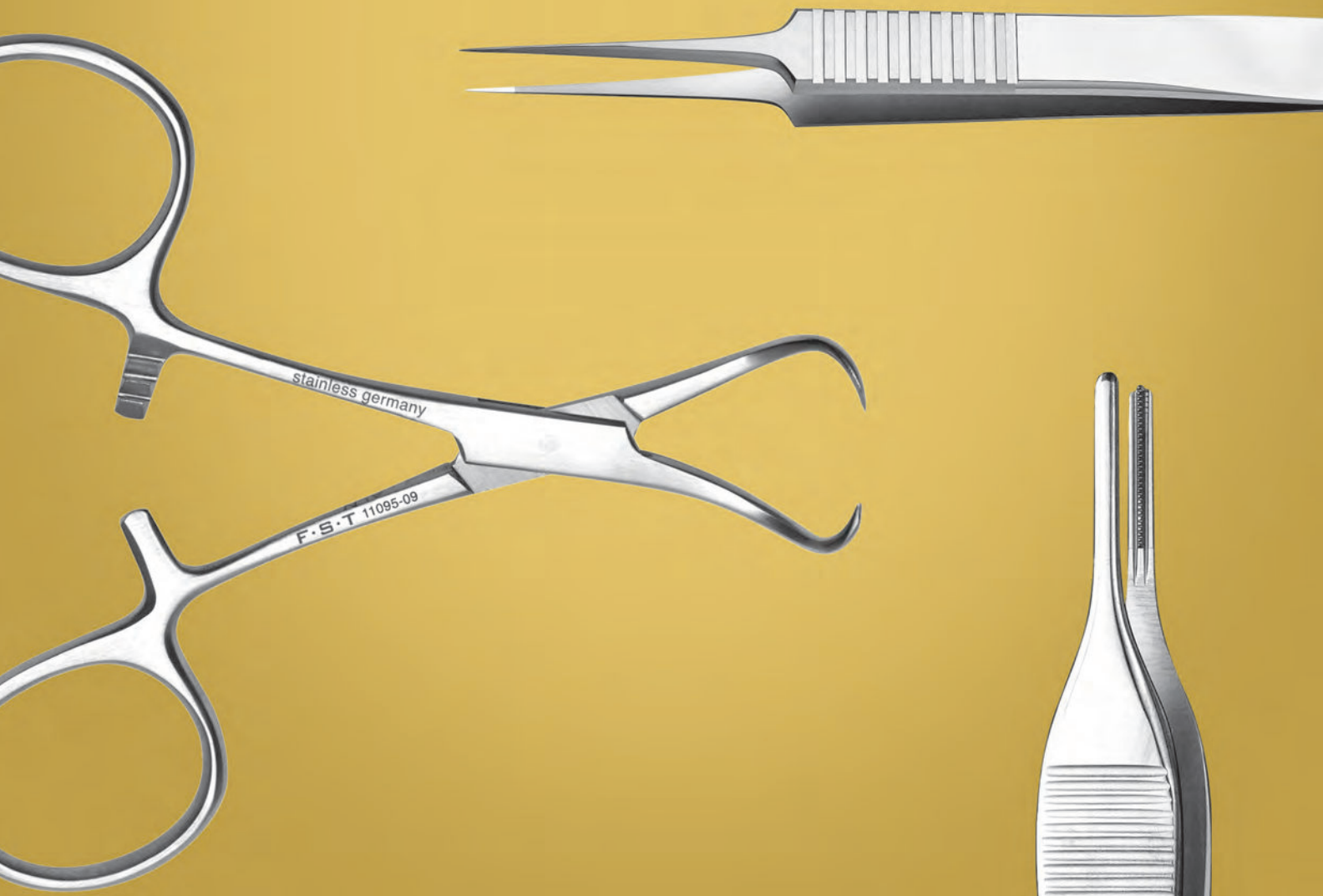

Dumont #5SF

The finest tips ever produced by Dumont.

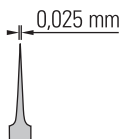

Super fine tip
11 cm
Inox
0.025 x 0.005 mm
No. 11252-00

Dumont #5 Fine Tips

Finished under magnification and polished on the inside, the tips close flat to 3 mm and are less likely to open under excess pressure.

MOST POPULAR

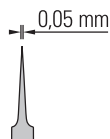

Biology tip
11 cm
Inox
0.05 x 0.01 mm
No. 11254-20

Dumont #5 Ceramic Coated

These forceps are non-reflective. The scratch and corrosion resistant coating guarantees durability.

CERAMIC COATED

For more information about our ceramic instruments please visit page 211.

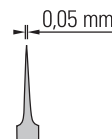

Biology tip
11 cm
Ceramic coated inox
0.05 x 0.01 mm
No. 11252-50

Dumont #5C0

These forceps have been honed down to make this the lightest and most precise Dumont forceps available.

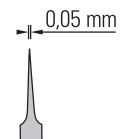

Biology tip
11 cm
Dumostar
0.05 x 0.01 mm
No. 11295-20

FORCEPS

For information on Dumont alloys and tip styles, see page 217.

Dumont Micro-Blunted, Atraumatic Tipped Forceps

The sides of these forceps are distinctively ribbed to provide a better holding surface for maximum control of the instrument. The shanks are arched toward each other to transmit more holding strength to the points. The smooth inside surfaces at the tips will close flat to 5 mm with gentle pressure, increasing the total holding area considerably. The microscopically matched tips are gently blunted to prevent tissue puncture and are recommended as micro needle holders.

FORCEPS

For information on Dumont alloys and tip styles, see page 217.



Medical #5	Medical #5A	Medical #7S	Medical #7	Medical #5/45	Medical #5/90
Straight	Off-center	Short curve	Curved	Angled 45°	Angled 90°
11 cm	11.5 cm	12 cm	11.5 cm	11 cm	11 cm
Inox	Inox	Inox	Inox	Inox	Inox
0.10 x 0.06 mm	0.13 x 0.08 mm	0.17 x 0.10 mm	0.17 x 0.10 mm	0.10 x 0.06 mm	0.10 x 0.06 mm
No. 11253-20	No. 11253-21	No. 11273-22	No. 11273-20	No. 11253-25	No. 11253-29

Dumont #55

Bevelled, like #5 but with extra light and fine shanks.

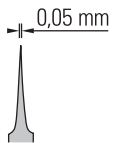

Biology tip

11 cm
Inox
0.05 x 0.02 mm
No. 11255-20

11 cm
Dumostar
0.05 x 0.02 mm
No. 11295-51

Dumont #5 Mirror Finish Forceps

The last 5 mm on the inside of the tips are highly polished to help prevent tissue from sticking. Ideal for embryos, nerves, or any other adhesive tissue.

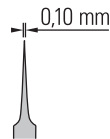

Standard tip

11 cm
Inox
0.10 x 0.06 mm
No. 11251-23

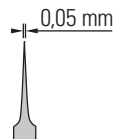

Biology tip

11 cm
Inox
0.05 x 0.02 mm
No. 11252-23

Dumont #5

These are the most widely used Dumont forceps. Bevelled, very fine shanks for best visibility.

MOST POPULAR

11251-20
11252-20

135°C NOT AUTOCLAVABLE

11251-10

TITANIUM

11252-40

For more information see page 211.

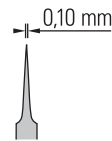

Standard tip

11 cm
Inox
0.10 x 0.06 mm
No. 11251-20

Dumoxel

No. 11251-30

Dumostar

No. 11295-00

11 cm
Carbon
0.08 x 0.04 mm
No. 11251-10

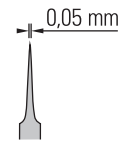

Biology tip

11 cm
Inox
0.05 x 0.02 mm
No. 11252-20

Dumoxel

No. 11252-30

Dumostar

No. 11295-10

Titanium
No. 11252-40

For information on Dumont alloys and tip styles, see page 217.

Dumont WA #5

These specially designed forceps offer improved stability with an ergonomic body that allows the forceps to fit more comfortably in your hand. A domed end with no soldering grooves allows the forceps to be thoroughly and easily cleaned, preventing biofilm residues.

Dumont #5XL

FORCEPS

For information on Dumont alloys and tip styles, see page 217.



Side View

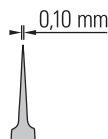

Standard tip

12 cm
Inox
0.10 x 0.06 mm

No. 11251-21

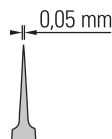

Biology tip

12 cm
Inox
0.05 x 0.02 mm

No. 11252-21

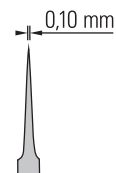

Standard tip

15 cm
Inox
0.10 x 0.06 mm

No. 11253-10

Dumont #L5

Slide sleeve keeps tips together so specimens may be securely held and retained. Slide may be locked in place so that forceps can be used in regular fashion.

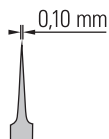

Standard tip
11 cm
Inox
0.10 x 0.06 mm

No. 11253-27

Dumont #5 Teflon® Coated

These antimagnetic forceps are ideal for use in cryogenic environments and for EM samples. Teflon® coating provides a non-stick surface.

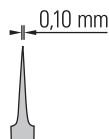

Standard tip
11 cm
Teflon coated inox
0.10 x 0.06 mm

No. 11626-11

Dumont #5/45

45° tips for improved visibility and control.

MOST
POPULAR



Standard tip
11 cm
Dumoxel
0.10 x 0.06 mm

No. 11251-35

Dumont #5/45 Cover Slip Forceps

Designed to pick up cover slips out of multi-well plates. The tip width is squared for a better grip.



300%

For information on
Dumont alloys
and tip styles,
see page 217.

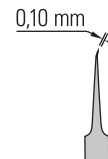

1 mm from tip to bend
11.5 cm
Dumoxel
Upper tip: 0.10 x 0.08 mm
Lower tip: 0.10 x 0.02 mm

No. 11251-33

FORCEPS

Dumont #3

Tapered and sturdy shanks.

Dumont #3c

Dumont #6

Sharply angled tips for access to difficult areas.

FORCEPS

For information on Dumont alloys and tip styles, see page 217.

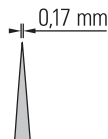
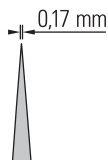
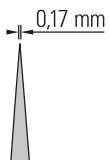

Standard tip

Standard tip

Standard tip

Standard tip

12 cm

12 cm

11 cm

11.5 cm

Dumoxel

Dumostar

Inox

Inox

0.17 x 0.10 mm

0.17 x 0.10 mm

0.17 x 0.10 mm

0.17 x 0.10 mm

No. 11231-30

No. 11293-00

No. 11231-20

No. 11260-20

Dumont #7 Fine Tips

Finished under magnification and polished on the inside, the tips close flat to 3 mm and therefore less likely to open under excess pressure.

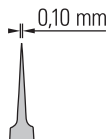

Biology tip
11 cm
Inox
0.07 x 0.03 mm
No. 11274-20

Dumont #7

TITANIUM

11272-40
For more information see page 211.

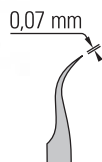

Biology tip
11.5 cm
Dumoxel
0.07 x 0.04 mm
No. 11272-30
Dumostar
No. 11297-10
Titanium
No. 11272-40

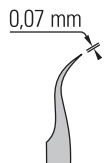

Standard tip
Dumoxel
No. 11271-30
Dumostar
No. 11297-00

**Dumont #7
Ceramic Coated**

**CERAMIC
COATED**

For more information about our ceramic instruments please visit page 211.



Biology tip
11 cm
Ceramic coated inox
0.07 x 0.04 mm
No. 11272-50

Dumont #7B

SERRATED

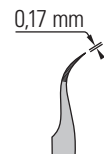

Standard tip
11 cm
Inox
0.17 x 0.10 mm
No. 11270-20

For information on Dumont alloys and tip styles, see page 217.

FORCEPS

Dumont #4

Similar to #5, but with broader shanks.

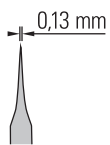

Standard tip
11 cm
Dumoxel
0.13 x 0.08 mm

No. 11241-30

Dumostar

No. 11294-00

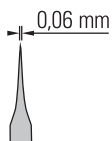

Biology tip
11 cm
Dumoxel
0.06 x 0.04 mm

No. 11242-40

Dumont #2 Laminectomy Forceps

These forceps can be used to break off delicate bone during mouse laminectomies, as well as fine skull bone removal.

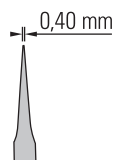

Standard tip
12 cm
Inox
0.40 x 0.02 mm

No. 11223-20

Dumont #2AP Epoxy Coated

Provides good insulation for up to 220 AC voltage work and highly impervious to chemical solutions. Frozen or super cold sections will not adhere to the gripping surfaces.

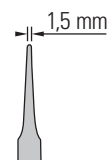

Standard tip
12 cm
Epoxy coated Inox
Tip width: 1.5 mm

No. 11220-21

For information on Dumont alloys and tip styles, see page 217.

Dumont AA

Dumont AA Epoxy Coated

Slip-proof acid and electric shock resistant epoxy coating covering 17.5 mm from the tips.

Dumont SS

The tips are smooth on the inside for a gentle grip. Applying full strength will not separate tips and a strong hold on the smallest specimen is ensured.



FORCEPS

For information on Dumont alloys and tip styles, see page 217.

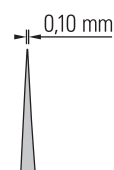
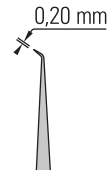
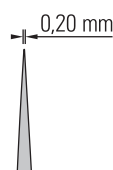
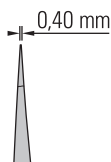
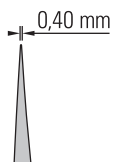

Standard tip

Standard tip

Standard tip

Angled 45°

Biology tip

12.5 cm
Inox
0.4 x 0.2 mm

12.5 cm
Epoxy coated inox
0.4 x 0.2 mm

13.5 cm
Inox
0.20 x 0.12 mm

13.5 cm
Inox
0.20 x 0.12 mm

13.5 cm
Dumoxel
0.10 x 0.06 mm

No. 11210-20

No. 11210-10

No. 11203-23

No. 11203-25

No. 11200-33

Dumont Mini Forceps

Dumont #2E
Components Forceps

Dumont #5AC

FORCEPS

For information on Dumont alloys and tip styles, see page 217.

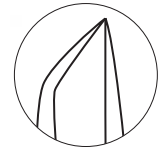

300%

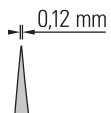

Style 3

7 cm
Inox
0.12 x 0.07 mm

No. 11200-10

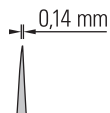

Style 4

7 cm
Inox
0.14 x 0.06 mm

No. 11200-12

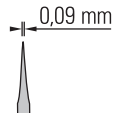

Style 5

8 cm
Inox
0.09 x 0.05 mm

No. 11200-14

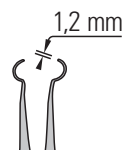

For components

11.5 cm
Dumoxel
8 x 1.2 mm

No. 11229-08



For components

11.5 cm
Dumoxel
10 x 1.2 mm

No. 11229-14



Biology Tip
Type #5 Anti-Capillary

11.5 cm
Inox
0.07 x 0.02 mm

No. 11258-20

Gold Plated Forceps

Gold-plating gives corrosion resistance to most chemicals, salts and acids. These forceps are perfect for any application where corrosion resistance and toughness are primary requirements.

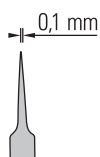

Straight

11.5 cm
0.1 x 0.06 mm

Gold Plated
Stainless Steel

No. 11915-11

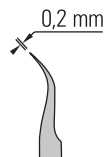

Curved

11.5 cm
0.2 x 0.1 mm

Gold Plated
Stainless Steel

No. 11917-12

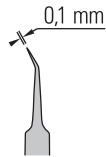

Angled 30°

11.5 cm
0.1 x 0.06 mm

Gold Plated
Stainless Steel

No. 11911-11

Diamond Coated Forceps

Diamond coating provides increased corrosion resistance and greater protection from wear and tear, which extends the operational life of the forceps, as well as providing a stronger grip at the tips.

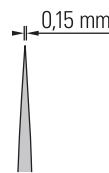

Straight

14 cm
0.15 x 0.1 mm

Diamond Coated
Stainless Steel

No. 11990-14

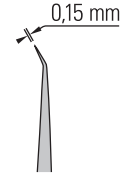

Angled 30°

14 cm
0.15 x 0.1 mm

Diamond Coated
Stainless Steel

No. 11991-14

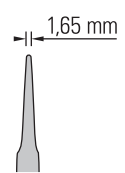

Straight

12 cm
1.65 x 0.05 mm

Diamond Coated
Stainless Steel

No. 11992-12

Mirror Finish Broad Shanks

These forceps have long and narrow shanks with thin, highly polished tips to prevent tissue from sticking. Ideal for embryos, nerves, or other adhesive tissues.

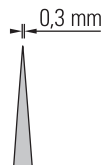

Straight
13 cm
0.3 x 0.15 mm
No. 11923-13

#2A Forceps

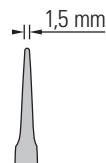

Straight
12 cm
1.5 x 0.13 mm
Stainless Steel
No. 11992-20

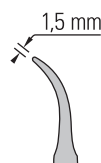

Curved
13 cm
1.5 x 0.1 mm
Stainless Steel
No. 11972-20

Forceps with Replaceable Tips

Stainless steel body with replaceable plastic tips. Tips are made of polyvinylidene fluoride (PVDF) and are electrostatic discharge (ESD) safe. Body and plastic tips are corrosion and abrasion resistant.

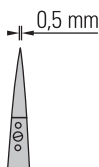

Straight
13 cm
0.5 x 0.5 mm
Stainless Steel body with replaceable plastic tips
No. 11980-13



Pkg. of 2 tips and 3 screws
Replacement plastic tips
Straight, strong
4 cm
0.5 mm
No. 11988-01



Pkg. of 2 tips and 3 screws
Replacement plastic tips
Straight, very fine
4 cm
0.5 mm
No. 11988-02



Pkg. of 2 tips and 3 screws
Replacement plastic tips
Curved
4 cm
0.5 mm
No. 11988-03

Fine Forceps Broad Shanks

Straight forceps with sturdy coarse tips.

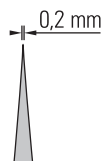

12 cm
0.2 x 0.12 mm
No. 11445-12

Fine Forceps Mirror Finish

The last 5 mm on the inside of the tips are highly polished to help prevent tissue from sticking. Ideal for embryos, nerves, or other adhesive tissue.

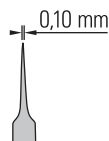

11 cm
0.10 x 0.06 mm
No. 11412-11

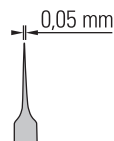

11 cm
0.05 x 0.02 mm
No. 11413-11

Fine Forceps Self-Closing

Ideal for lifting and holding EM grids. Consistent pressure at tips. Correctly tensioned "cross-over" shanks come to a microscopically matched point.

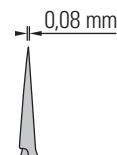

11.5 cm
0.08 x 0.04 mm
No. 11480-11

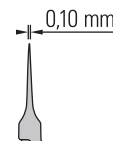

11 cm
0.10 x 0.06 mm
No. 11485-11

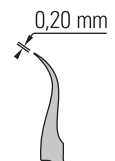

11.5 cm
0.20 x 0.12 mm
No. 11487-11

Moria Ultra Fine Forceps

These forceps have the most finely executed points available. They are extremely light, superbly balanced, and have a gentle spring action. The shanks are specially designed with an arch which ensures maximum force to the tips. The tips close flat for 6 mm from the points to give a large holding area. The tips have been expertly finished under magnification.

Moria Iris Forceps

Balanced with gentle spring action and tips that are perfectly matched.

FORCEPS



Moria MC40

Moria MC40/B

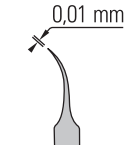
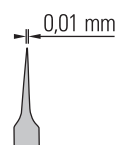

Straight

Curved

11 cm

11 cm

No. 11370-40

No. 11370-42

Moria 9980

Moria 9987

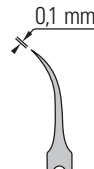
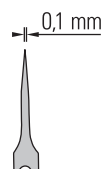

Straight

Curved

13 cm

13 cm

No. 11399-80

No. 11399-87

Moria MC32/B

Moria MC31/B

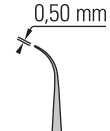
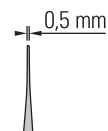

Smooth
Blunt

Smooth
Blunt

10 cm

10 cm

Tip width: 0.5 mm

Tip width: 0.5 mm

No. 11373-22

No. 11373-12

Moria MC32

Moria MC31

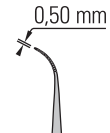
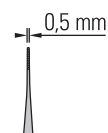

Microserrated

Microserrated

No. 11370-32

No. 11370-31

Moria Bonn Forceps



•TITANIUM•

11383-56
For more information
see page 211.



Moria 7835

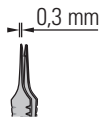

Straight
1x2 teeth and tying
platform
7.5 cm
Tip width: 0.3 mm
Tying platform: 4 mm
Stainless Steel

No. 11383-50

Moria T17835

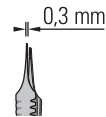

Straight
1x2 teeth and tying
platform
7.5 cm
Tip width: 0.3 mm
Tying platform: 4 mm
Titanium

No. 11383-56

Moria Paufigue Forceps

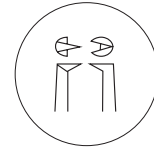

20x magnification



Moria 3225

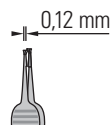

Straight
1x2 teeth with tying
platform
8.5 cm
Tip width: 0.12 mm
Tying platform: 5 mm

No. 11390-25

Fine Forceps

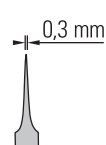

Straight

11 cm
0.3 x 0.25 mm

No. 00108-11

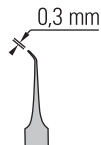

Angled 45°

11 cm
0.3 x 0.25 mm

No. 00109-11

SuperGrip Forceps

The tips are processed with MicroCrystals®, a method developed by S&T® to infuse tungsten carbide on stainless steel. The formation of this ultra-fine coating guarantees atraumatic handling of tissue while improving the grip dramatically. The recommended use is where forceps are utilized as needle holders or when slippery tissues might be encountered.



300%

The gripping surface is similar to a match head.

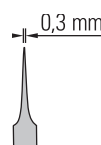

Straight

11 cm
0.3 x 0.25 mm

No. 00632-11

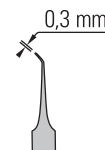

Angled 45°

11 cm
0.3 x 0.25 mm

No. 00649-11

Bonn

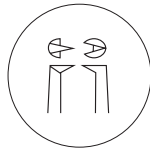

20x magnification

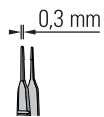

Smooth

7 cm

Tip width: 0.3 mm

Tying Platform: 5 mm

No. 11083-07

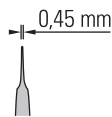

1x2 teeth

7 cm

Tip width: 0.45 mm

Teeth width: 0.1 mm

No. 11084-07

Mirror Finish Bonn Forceps

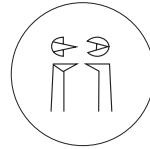

20x magnification

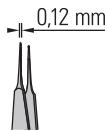

Straight
1x2 teeth

10.5 cm

Tip width: 0.12 mm

Tying Platform: 5 mm
Partly polished

No. 11090-10

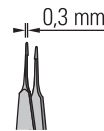

Straight

10.5 cm

Tip diameter: 0.3 mm

Tying Platform: 5 mm
Partly polished

No. 11093-10

Mirror Finish Suture Tying Forceps with Teeth

A unique tip style fusing a suture tying platform and a 1x2 teeth tip for tissue manipulation.

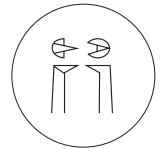

20x magnification

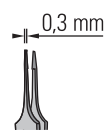

Straight

9 cm

Tip width: 0.3 mm

Platform with 1x2 teeth

No. 11090-09

Moria Suture Tying Forceps

Used to suture after surgery is complete. This requires the manipulation of a calibrated nylon thread and the use of a specific instrument: a tying forceps, straight or curved, without teeth.



Moria 9605

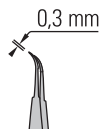

Curved
Smooth

9.5 cm
Tip diameter: 0.3 mm
Tying Platform: 7.5 mm

No. 11393-05

Moria 9604

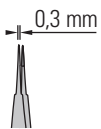

Straight
Smooth

9.5 cm
Tip diameter: 0.3 mm
Tying Platform: 8 mm

No. 11393-04

McPherson Forceps

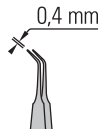

Angled 45°
Smooth

9 cm
Tip width: 0.4 mm
Tying Platform: 6 mm

No. 11063-07

Suture Tying Forceps

The platform tips close flat. This ensures a reliable grip on sutures.

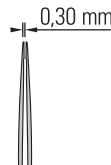
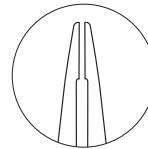

13.5 cm
Tip diameter: 0.3 mm
Tying platform: 6 mm

No. 00272-13

Suture Tying Forceps

The platform tips close flat. This ensures a reliable grip on sutures.

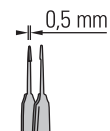

10 cm
Tip diameter: 0.5 mm
Tying platform: 5 mm

No. 18025-10

Round Handled Suture Tying Forceps

Round handles allow easy fingertip adjustments.

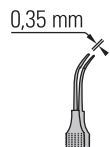

10.5 cm
Tip diameter: 0.35 mm
Tying platform: 5.5 mm
No. 18026-10

Vial Forceps

Tips taper for 6 cm allowing easy access to specimens in vials.

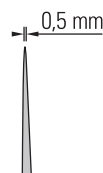
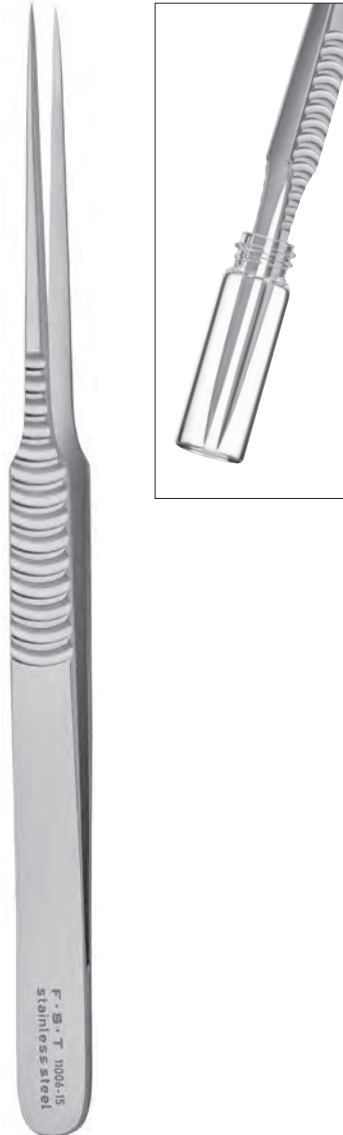

15 cm
Tip diameter: 0.5 mm
No. 11006-15

Vitro Grasping Forceps

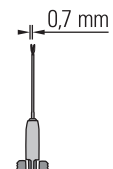

14 cm
Serrated
Tip diameter: 0.7 mm
No. 11900-14

Graefe Forceps

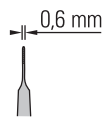

Straight
Serrated

7 cm
Tip width: 0.6 mm
No. 11064-07

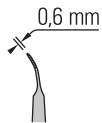

Curved
Serrated

7 cm
Tip width: 0.6 mm
No. 11065-07

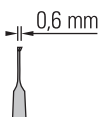

Straight
1x2 teeth

No. 11066-07

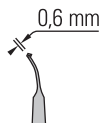

Curved
1x2 teeth

No. 11067-07

Bishop-Harman

Extra light, fenestrated handles ensure a good grip.

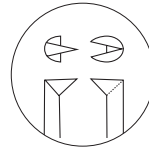

10x magnification

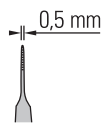

Serrated

8.5 cm
Tip width: 0.5 mm
No. 11069-08

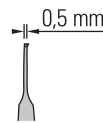

1x2 teeth

8.5 cm
Tip width: 0.5 mm
No. 11070-08

Octagon Forceps

The octagon shaped grip provides a particularly secure finger hold.

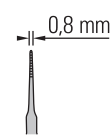

Straight
Serrated

9.5 cm
Tip width: 0.8 mm
No. 11040-08

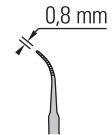

Curved
Serrated

9.5 cm
Tip width: 0.8 mm
No. 11041-08

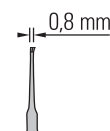

Straight
1x2 teeth

No. 11042-08

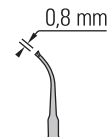

Curved
1x2 teeth

No. 11043-08

Extra Fine Graefe Forceps



80% of actual size

Graefe Forceps

MOST POPULAR

11051-10
11054-10

TITANIUM

11650-10 – 11652-10
For more information see page 211.

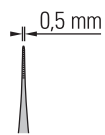

Serrated
10 cm
Tip width: 0.5 mm
No. 11150-10

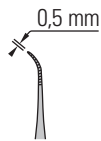

Serrated
10 cm
Tip width: 0.5 mm
No. 11151-10



Serrated
10 cm
Tip width: 0.5 mm
No. 11152-10

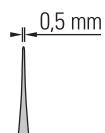

Smooth
No. 11158-10

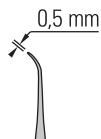

Smooth
No. 11159-10

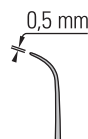

Smooth
No. 11160-10

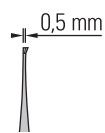

1x2 teeth
No. 11153-10

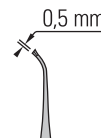

1x2 teeth
No. 11154-10



1x2 teeth
No. 11155-10

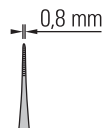

Serrated
Tip width: 0.8 mm
No. 11050-10

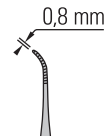

Serrated
Tip width: 0.8 mm
No. 11051-10

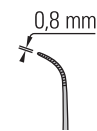

Serrated
Tip width: 0.8 mm
No. 11052-10

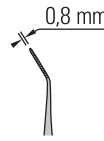

Serrated
Tip width: 0.8 mm
No. 11049-10

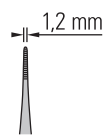

Titanium
Tip width: 1.2 mm
No. 11650-10

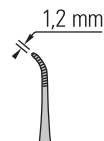

Titanium
Tip width: 1.2 mm
No. 11651-10

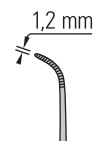

Titanium
Tip width: 1.2 mm
No. 11652-10

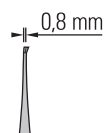

1x2 teeth
Tip width: 0.8 mm
No. 11053-10

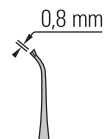

1x2 teeth
Tip width: 0.8 mm
No. 11054-10

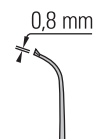

1x2 teeth
Tip width: 0.8 mm
No. 11055-10



Sliding Lock Forceps

Episcleral Forceps

Pierson Fixation Forceps

The tips of these forceps arch toward each other, closing flat. Exceptional gripping power is possible with minimal damage to tissue. A limit pin prevents excessive applied pressure.

For exceptional gripping power with no damage to sclera, vascular sheath and epineurium.

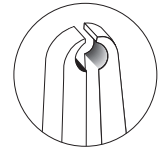

Smooth
11 cm
Tip width: 1 mm
Slide lock
No. 11062-10



10 cm
Tip thickness: 0.2 mm
Tip Dimension: 1.3 x 3 mm
No. 11071-10



Straight
13 cm
Tip Dimension: 0.1 x 0.4 mm
No. 18155-13

Plastic Forceps

These forceps are non-magnetic, acid resistant and able to withstand temperatures up to 240°C (464°F). Tips do not spread under pressure. Plastic forceps are made of Acetyl and will be sold in packages of 10 pieces.



Sharp
Straight
11.5 cm
0.40 x 0.25 mm
No. 11700-00



Blunt
Straight
11.5 cm
1.5 x 0.40 mm
No. 11700-03

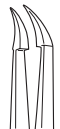

Sharp
Curved
11.5 cm
0.30 x 0.20 mm
No. 11700-01



Blunt
Curved
11.5 cm
1.5 x 0.40 mm
No. 11700-04

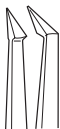

Sharp
Angled 45°
11.5 cm
0.30 x 0.20 mm
No. 11700-02

Cross Action Forceps

These tissue transport forceps have a gentle action.

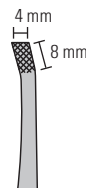

Cross serrated
10 cm
Tip Dimension: 4 x 8 mm
No. 11075-00

Cover Glass Forceps

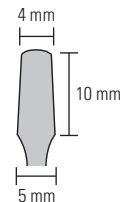

Straight
10.5 cm
Tip Dimension:
4 x 5 x 10 mm
No. 11074-02



Angled
10.5 cm
Tip Dimension:
4 x 5 x 10 mm
No. 11073-10

Ring Forceps

For transport of tissue and organs. With limit screw to prevent excessive applied pressure.



8.5 cm
 Inner Diameter: 1 mm
 Outer Diameter: 1.5 mm
 Ring width: 0.5 mm

No. 11101-09



9 cm
 Inner Diameter: 2.2 mm
 Outer Diameter: 3 mm
 Ring width: 1.3 mm

No. 11103-09



9 cm
 Inner Diameter: 4.8 mm
 Outer Diameter: 6 mm
 Ring width: 1.5 mm

No. 11106-09

Circle Forceps

Cupped forceps for atraumatic gripping of organs and tissues.



11.5 cm
 Tip diameter: 0.7 mm

No. 11072-11

Live Insect Handling Forceps

Very delicate.



Narrow
 10 cm

No. 26029-10



Wide
 10 cm

No. 26030-10

Micro-Adson

Our most delicate version of the popular Adson forceps.

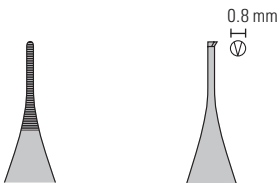

Serrated	1x2 teeth
12 cm	12 cm
Tip width: 0.8 mm	0.8 mm
No. 11018-12	No. 11019-12

Micro-Adson with Fenestrated Handle

Our delicate Micro-Adson forceps, with five windows to aid in stability and easy finger adjustments.

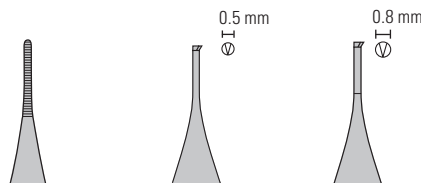

Serrated	1x2 teeth	1x2 teeth with 6 mm platform
12 cm	12 cm	12 cm
0.8 mm	0.5 mm	0.8 mm
No. 11020-12	No. 11032-12	No. 11022-12

Adson

Wide, strong grip with narrow tips.

MOST POPULAR
11006-12
11027-12

TUNGSTEN CARBIDE
11506-12
For more information see page 211.

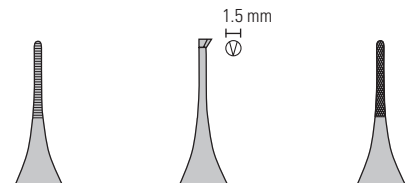

Serrated	1x2 teeth	Cross serrated tungsten carbide inlaid tip
12 cm	12 cm	12 cm
1.5 mm	1.5 mm	1.5 mm
No. 11006-12	No. 11027-12	No. 11506-12

FORCEPS

Adson DeBakey

Adson-Graefe

Adson-Brown

FORCEPS

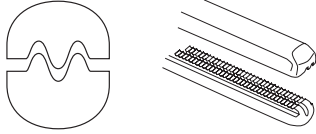
Atraumatic DeBakey Serrations

This tooth pattern, as shown, consists of one row of atraumatic teeth meshed with two opposite rows of atraumatic teeth.

These two forceps are ideal for gentle, atraumatic gripping of vessels, tissue and other delicate structures.



DeBakey serrations
12.5 cm
Tip width: 1.5 mm
No. 11617-12



DeBakey serrations
15 cm
Tip width: 1.5 mm
No. 11616-15



Fine sharp teeth
12.5 cm
Tip width: 4.5 mm
No. 11030-12

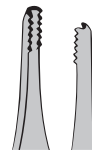

Shark teeth
12 cm
Tip width: 1.4 mm
No. 11627-12

Standard Pattern

Broad pattern with strong spring action.



Straight Serrated

Tip width (mm)	Length (cm)	Item	Price
2.5	12	No. 11000-12	
2.8	13	No. 11000-13	
3.25	14.5	No. 11000-14	
3.3	16	No. 11000-16	
3.7	18	No. 11000-18	
3.75	20	No. 11000-20	
3.9	25	No. 11000-25	
4	30	No. 11000-30	

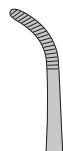

Curved Serrated

Tip width (mm)	Length (cm)	Item	Price
2.5	12	No. 11001-12	
2.8	13	No. 11001-13	
3.25	14.5	No. 11001-14	
3.3	16	No. 11001-16	
3.7	18	No. 11001-18	
3.75	20	No. 11001-20	

Narrow Pattern

Lighter spring action than standard pattern for grasping more delicate tissue.

•TITANIUM•

11602-14
For more information see page 211.



Straight Serrated

Tip width (mm)	Length (cm)	Item	Price
2	12	No. 11002-12	
2.15	13	No. 11002-13	
2.25	14.5	No. 11002-14	
2.25	14.5	No. 11602-14	
2.35	16	No. 11002-16	
2.4	18	No. 11002-18	
2.75	20	No. 11002-20	
3.2	25	No. 11002-25	

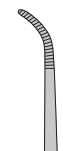

Curved Serrated

Tip width (mm)	Length (cm)	Item	Price
2	12	No. 11003-12	
2.15	13	No. 11003-13	
2.25	14.5	No. 11003-14	
2.35	16	No. 11003-16	
2.4	18	No. 11003-18	
2.75	20	No. 11003-20	

FORCEPS

Semken

Slim pattern with long, narrow shanks and gentle spring action.

•TITANIUM•

11608-15
For more information
see page 211.



Straight
Serrated

Tip width (mm)	Length (cm)	Item	Price
1.3	13	No. 11008-13	
1.5	15	No. 11008-15	
1.5	15	No. 11608-15	



Curved
Serrated

Tip width (mm)	Length (cm)	Item	Price
1.3	13	No. 11009-13	
1.5	15	No. 11009-15	

DeBakey Round Handle Forceps

Ideal for gentle, atraumatic gripping of vessels, tissue and other delicate structures. Two rows of atraumatic teeth interfit with one opposite row of atraumatic teeth. The round handles allow easy fingertip adjustments.



DeBakey serrations

15 cm
Tip width: 1.2 mm
No. 11076-15

Multipurpose Forceps

Balanced instruments are designed to put the center of gravity between the thumb and index finger. This is accomplished by adding a slight counter weight to the proximal end of the instruments. The design enhances tactile feel, aiding in better control and precision.

The tips of these multipurpose forceps are configured to enable their use as dilators at the front, as well as needle holders and tying forceps further in the back. The platform at the tips close parallel ensuring a reliable grip.



80% of
actual size



Straight

14.5 cm
Suture tying platform
Tip diameter: 0.1 mm

No. 18601-15



80% of
actual size



Straight

15 cm
Suture tying platform
Tip diameter: 0.3 mm

No. 18602-15



80% of
actual size



Angled

14.5 cm
Smooth
Tip diameter: 0.2 mm

No. 18603-14

Tissue Forceps



Straight
Narrow 1x2 teeth
10 cm
No. 11023-10

Straight
Narrow 1x2 teeth
12 cm
No. 11023-12

Straight
Narrow 1x2 teeth
14.5 cm
No. 11023-14

Straight
Narrow 1x2 teeth
15.5 cm
No. 11023-15



Straight
Standard 1x2 teeth
12 cm
No. 11021-12

Straight
Standard 1x2 teeth
14.5 cm
No. 11021-14



Straight
Standard 2x3 teeth
14.5 cm
No. 11022-14

Straight
Standard 2x3 teeth
15.5 cm
No. 11022-15



Curved
Narrow 1x2 teeth
14 cm
No. 11029-14

Tissue Forceps

Used with rongeur No. 16021-14 (page 36) in laminectomy to securely hold spinal column.

Gillies

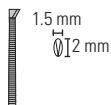

Cross-Serrated
1x2 teeth
15 cm
Tip Dimension: 1.5 x 2 mm
No. 11028-15

Russian

Special cupped pattern for superior grip.

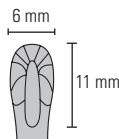

15 cm
Tip Dimension: 6 x 11 mm
No. 11026-15

Organ Holding Forceps

With limit screw to prevent excessive applied pressure.

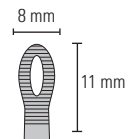

Serrated
14.5 cm
Tip Dimension: 8 x 11 mm
No. 11031-15

London Forceps

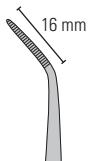

Angled
Serrated

16 cm

No. 11080-02

Titanium Forceps

•TITANIUM•

For more information
see page 211.



Straight
Serrated

16 cm

No. 11602-16

Gerald Forceps



Straight
Serrated

18 cm

No. 11014-18

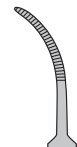

Curved
Serrated

18 cm

No. 11015-18

Taylor Forceps

Serrated and smooth versions available.



 Straight Serrated
 17 cm
 No. 11010-17



 Straight Smooth
 17 cm
 No. 11016-17

 Curved Smooth
 17 cm
 No. 11017-17



 Curved Serrated
 17 cm
 No. 11011-17

Potts-Smith Forceps





 Straight Serrated
 18 cm
 No. 11012-18

21 cm
 No. 11012-21
 25 cm
 No. 11012-25

 Curved Serrated
 18 cm
 No. 11013-18

21 cm
 No. 11013-21

 Curved 1x2 teeth
 18 cm
 No. 11025-18

 Straight 1x2 teeth
 18 cm
 No. 11024-18

Mouse Handling Forceps

Long handles make picking up small rodents easy and help prevent bites.



21 cm
 Forceps with serrated silicone tips
 Gripping surface: 15 x 20 mm
 No. 11036-20



Replacement silicone tips
 Pkg of 2 tips
 No. 11036-90

FORCEPS

Ultra Fine Hemostat



Straight
Smooth

12 cm
Tip width: 0.6 mm

No. 13020-12



Curved
Smooth

12 cm
Tip width: 0.6 mm

No. 13021-12

Fine Hemostat



Straight
Smooth

12 cm
Tip width: 1 mm

No. 13006-12



Curved
Smooth

12 cm
Tip width: 1 mm

No. 13007-12

Micro-Mosquito



Straight Serrated

12 cm
Tip width: 1.3 mm

No. 13010-12



Curved Serrated

12 cm
Tip width: 1.3 mm

No. 13011-12

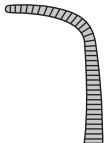

Angled 90° Serrated

12 cm
Tip width: 1.3 mm

No. 13012-12

Halsted-Mosquito



13108-12



13008-12



13109-12



Straight Serrated

12.5 cm
Tip width: 1 mm

No. 13008-12



Curved Serrated

12.5 cm
Tip width: 1 mm

No. 13009-12



Straight Serrated

12.5 cm
Tip width: 1 mm
Left handed

No. 13108-12



Curved Serrated

12.5 cm
Tip width: 1 mm
Left handed

No. 13109-12

HEMOSTATS

Crile



Straight
Serrated

14 cm
Tip width: 1.5 mm

No. 13004-14

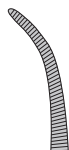

Curved
Serrated

14 cm
Tip width: 1.5 mm

No. 13005-14

Kelly



Straight
Serrated

14 cm
Tip width: 1.5 mm

No. 13018-14

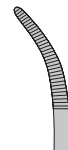

Curved
Serrated

14 cm
Tip width: 1.5 mm

No. 13019-14

Baby-Mixer

Providence-Hospital



HEMOSTATS

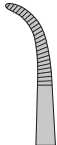

Curved
Serrated
14 cm
Tip width: 1.3 mm
No. 13013-14



Straight
Serrated
14 cm
Tip width: 1.5 mm
No. 13014-14



Curved
Serrated
14 cm
Tip width: 1.5 mm
No. 13015-14

Hartman

MOST POPULAR

13003-10



Straight Serrated

10 cm
Tip width: 1 mm

No. 13002-10



Curved Serrated

10 cm
Tip width: 1 mm

No. 13003-10

Backhaus Towel Clamp



9 cm

No. 11095-09



13 cm

No. 11095-13

Allis Clamp

Tissue and organ holding forceps.



Lorna Towel Clamp



HEMOSTATS

Allis

④ 4 mm

5x6 teeth

15 cm

Tip width: 4 mm

No. 11091-15

Allis-Baby

③ 3 mm

4x5 teeth

12 cm

Tip width: 3 mm

No. 11092-12



Serrated

10 cm

Tip width: 6 mm

No. 11096-10



Serrated

13 cm

Tip width: 7 mm

No. 11096-13

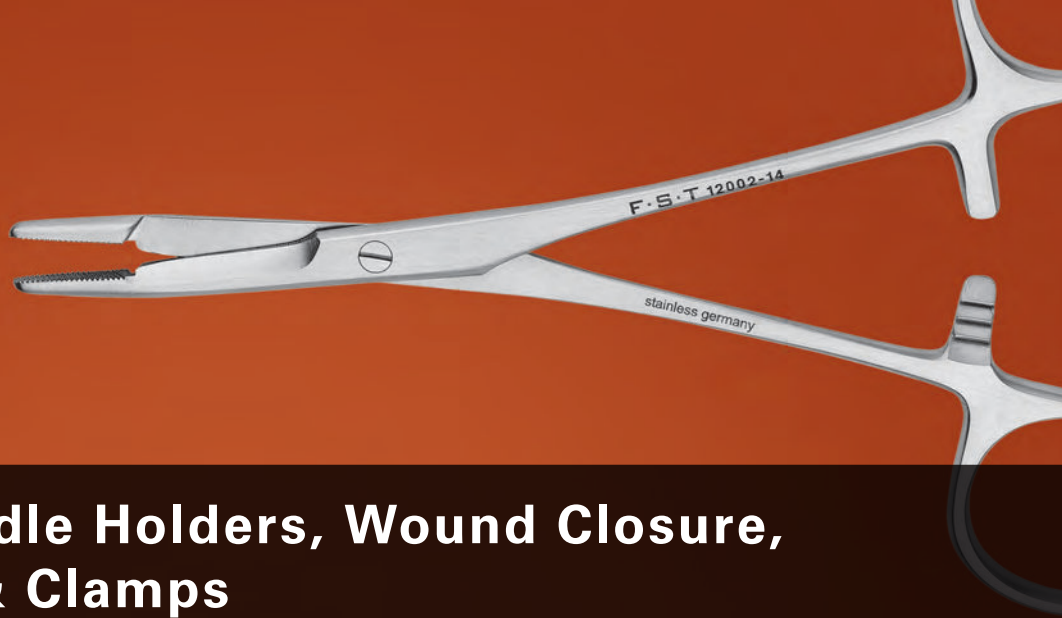

Probes, Needle Holders, Wound Closure, Retractors & Clamps

Probes & Hooks	Pages	105 – 109
Spatulae	Pages	108 – 112
Hippocampal Tools	Page	112
Spoons	Page	113
Pins & Holders	Pages	114 – 115
Wound Closure	Pages	116 – 127
Retractors	Pages	128 – 135
Vascular Instruments	Pages	136 – 145

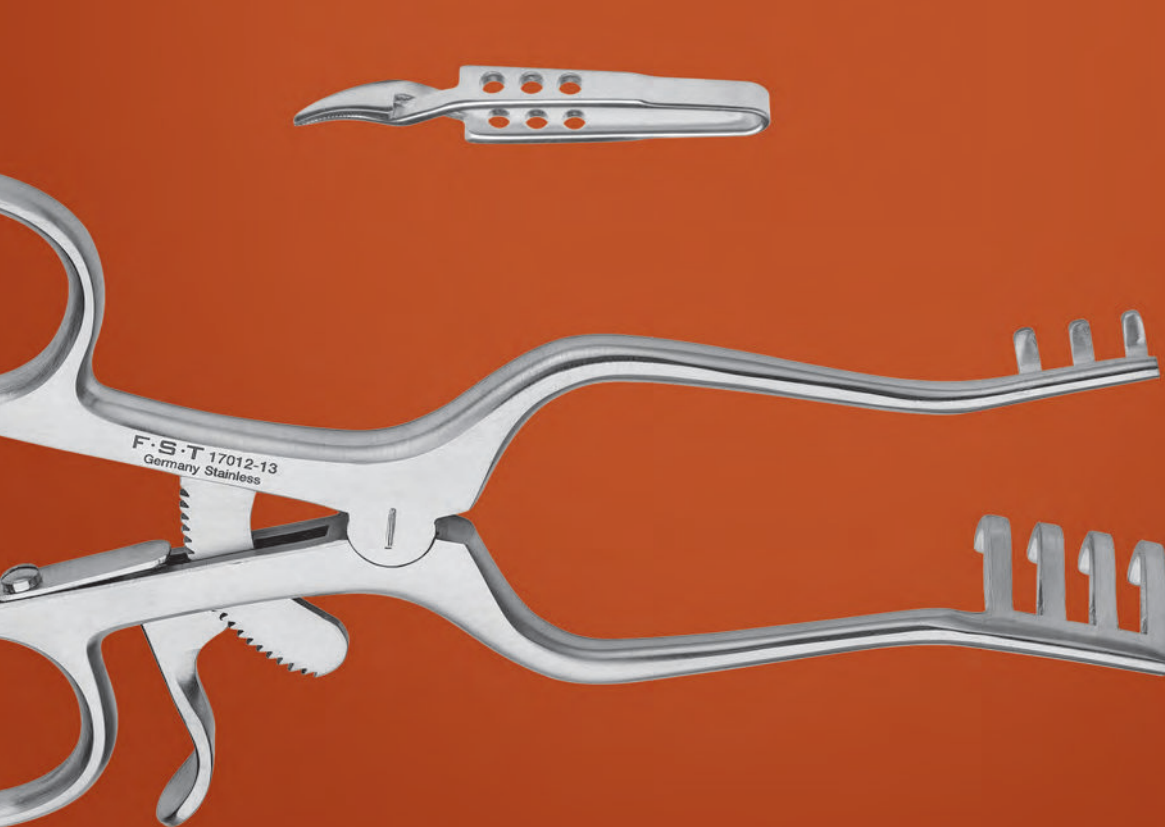

Double Pronged Pick

For peritoneum, pleura, endocardium, organ capsules and skin.
Grasps and lifts skin, tissue and dura, etc.

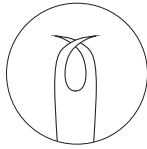

700%

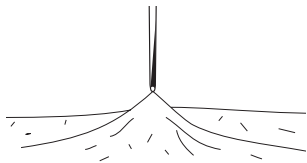

The tip consists of two very sharp, nearly horizontally opposed points. By applying gentle downward pressure and twisting slightly in a clockwise fashion, the points will embed themselves horizontally into fine membranes or skin, etc., so that it may be lifted upward. This instrument also has been used successfully when separating fine tissue from an underlying area that is not to be cut.

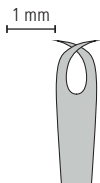

11 cm
Tip diameter: 1 mm

No. 18067-11

Spinal Cord Hook

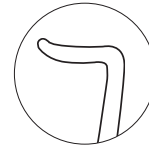

300%

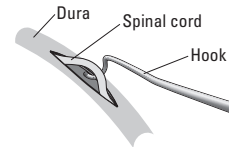

Shaped like a ligation aid and sized to isolate the spinal cord from the dura of adult mice and neonatal rats. The cord can then be cut with minimal damage to the dura.



12 cm
Tip diameter: 3 mm

No. 10162-12

Bonn Micro Probes

Micro Points



Actual size

Angled 45°

13.5 cm
Tip diameter: 0.025 mm

No. 10032-13



Actual size

Straight

13.5 cm
Tip diameter: 0.025 mm

No. 10030-13



Actual size

Large curve

13.5 cm
Tip diameter: 0.038 mm

No. 10033-13



Actual size

Curved

13.5 cm
Tip diameter: 0.025 mm

No. 10031-13



300%

Angled 90° short

15.5 cm
Tip diameter: 0.05 mm

No. 10063-15



300%

Angled 45°

15.5 cm
Tip diameter: 0.038 mm

No. 10066-15



300%

Angled 90°

15.5 cm
Tip diameter: 0.02 mm

No. 10065-15

Probes and Explorers

Micro Hooks

MOST POPULAR
10140-01



Actual size

Short angle

15.5 cm
Tip diameter: 0.12 mm

No. 10140-04



Actual size

Straight

15.5 cm
Tip diameter: 0.25 mm

No. 10140-01



Actual size

Long angled

15.5 cm
Tip diameter: 0.15 mm

No. 10140-03



Actual size

Angled

15.5 cm
Tip diameter: 0.15 mm

No. 10140-02



175%

Short round hook

13 cm
Tip diameter: 0.05 mm

No. 10064-14



175%

Blunt hook

12 cm
Tip diameter: 0.30 mm

No. 10062-12



175%

Sharp hook

12 cm
Tip diameter: 0.075 mm

No. 10061-12

Titanium Micro Point, Y-Hook, and Spatula

These instruments are lightweight, color coded for easy identification, have an ergonomic design and a non-reflective surface.

•TITANIUM•

For more information
see page 211.



650%

Micro Point



Angled 45°

12.5 cm
Tip diameter: 0.4 mm

No. 10165-11

•TITANIUM•

For more information
see page 211.



700%

Y-Hook



Angled 45°

12.5 cm
Tip width: 0.5 mm

No. 10166-11

•TITANIUM•

For more information
see page 211.



700%

Micro Spatula



Angled 30°

12.5 cm
Tip width: 0.6 mm
Tip thickness: 0.25 mm

No. 10167-11

Vessel Dilating Probe

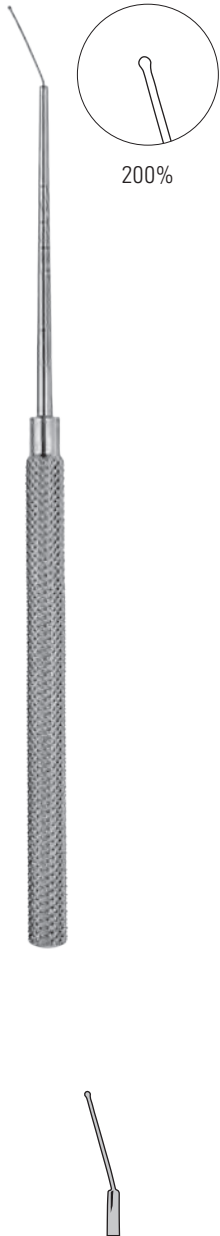

Angled 45°
 12.5 cm
 Tip diameter: 0.6 mm
 No. 10160-13

Gross Anatomy Probe

MOST POPULAR



Angled 45°
 15 cm
 Tip diameter: 1.2 mm
 No. 10088-15

Combination Probe and Spatula



14 cm
 Spatula dimension: 13 x 7 x 0.6 mm
 Tip diameter: 0.1 mm
 No. 10090-13

Combination Spoon and Spatula



17.5 cm
 Spoon diameter: 30 x 7 mm
 Spatula dimension: 30 x 7 mm
 Spoon diameter: 7 mm
 No. 10090-17

SPATULAE

SPATULAE

Micro Spatula

Mirror Finish Micro Spatula

Mirror finished to provide a non-stick spatula.

Double-Ended Micro Spatula

MOST POPULAR

Iris Spatulae

SPATULAE



Straight

11 cm
Tip width: 1 mm
Tip thickness: 0.25 mm

No. 10089-11



Slightly curved

12 cm
Tip width: 0.8 mm
Tip thickness: 0.25 mm

No. 10087-12

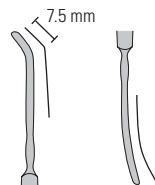
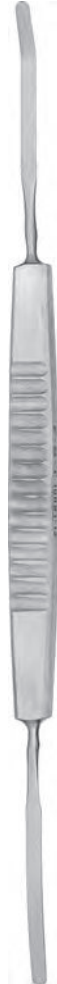

Angled

13 cm
Tip width: 2 mm
Tip thickness: 0.3 mm

No. 10091-12

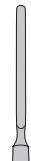

Straight

13 cm
Tip width: 3 mm
Tip thickness: 0.4 mm

No. 10094-13



Slightly curved

13 cm
Tip width: 1.7 mm
Tip thickness: 0.3 mm

No. 10093-13

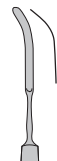

Curved

12 cm
Tip width: 1.8 mm
Tip thickness: 0.3 mm

No. 10092-12

Micro Spatula Kit

Kit with 4 pieces



150% of actual size

SPATULAE

Black



Straight

6 cm
Tip width: 0.2 mm

No. 10098-06

Blue



Straight

6 cm
Tip width: 0.3 mm

Green



Straight

6 cm
Tip width: 0.5 mm

Red



Straight

6 cm
Tip width: 0.7 mm

Mini Hippocampal Dissecting Tool

The instrument ends are malleable to allow you to adjust their shape to the correct angle for optimal positioning.



14.5 cm
Spatula dimension: 20 x 6 mm & 13 x 3 mm
Tip thickness: 0.5 mm

No. 10099-12

Hippocampal Dissecting Tool

The instrument ends are malleable to allow you to adjust their shape to the correct angle for optimal positioning.



16 cm
Spatula dimension: 27 x 14 mm & 27 x 6 mm
Tip thickness: 0.5 mm

No. 10099-15

Spoon



Moria 1121B

12.5 cm
Diameter: 8 mm
Depth: 2 mm

No. 10321-08

Mini Perforated Spoon

Most commonly used to take embryos out of solution and handling very small organs.



Moria MC 17C

10 cm
Diameter: 8 mm
Depth: 1 mm

Perforations: 0.8 mm
in diameter

No. 10370-19

Perforated Spoon

Most commonly used to take embryos out of solution and handling very small organs.

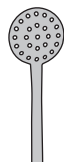

Moria MC 17 BIS

14.5 cm
Diameter: 15 mm
Depth: 3 mm

Perforations: 0.9 mm
in diameter

No. 10370-18

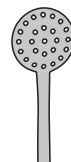

Moria MC 17

14.5 cm
Diameter: 20 mm
Depth: 5 mm

Perforations: 0.9 mm
in diameter

No. 10370-17

**Mirror Finish
Cutting Spoon**

Non stick cutting spoon.



13 cm
Diameter: 4.5 mm
Depth: 0.15 mm

No. 10360-13

SPOONS

Pin Holder

Light weight

MOST POPULAR



90% of actual size

17 cm
Nickel-plated chuck
Aluminum handle
Jaw opening: 0–1 mm

No. 26018-17

Pin Holder

MOST POPULAR

Moria



Moria MC1

12 cm
Nickel-plated
Jaw opening: 0–1 mm

No. 26016-12

Insert Pins

All insert pins fit any of our pin holders. Pins are antimagnetic and acid resistant.



Lancet	Straight	Curved
5 cm	5 cm	5 cm
Stainless steel	Stainless steel	Stainless steel
No. 26007-01	No. 26007-02	No. 26007-03



Lancet half	Spatula
5 cm	5 cm
Stainless steel	Stainless steel
No. 26007-04	No. 26007-05

Black Anodized Minutien Pins

These high quality pins are black for best visibility under high magnification and bright light.

Tip diameter: 0.0175 mm
Rod diameter: 0.15 mm
12 mm

Box of 500 pins
No. 26002-15 **MOST POPULAR**



Stainless Steel Minutien Pins

The thinnest and finest pins available.



Tip diameter: 0.0125 mm
Rod diameter: 0.1 mm
12 mm

Box of 500 pins
No. 26002-10 **MOST POPULAR**

Tip diameter: 0.0175 mm
Rod diameter: 0.15 mm
12 mm

Box of 500 pins
No. 26003-15 **MOST POPULAR**

Tip diameter: 0.02 mm
Rod diameter: 0.2 mm
12 mm

Box of 500 pins
No. 26002-20 **MOST POPULAR**

Black Anodized Insect Pins

Nylon heads
Tip diameter: 0.03 mm
Pkg. of 100 pins

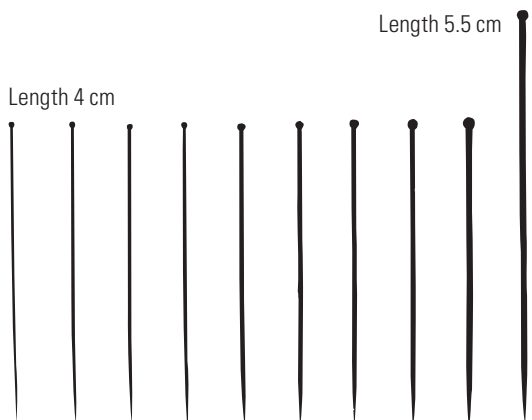

Size	000	00	0	1	2	3	4	5	6	7
Rod diameter (mm)	0.25	0.30	0.35	0.40	0.45	0.50	0.55	0.60	0.65	0.70
No. 26000	-25	-30	-35	-40	-45	-50	-55	-60	-65	-70

Stainless Steel Insect Pins

Nylon heads
Tip diameter: 0.03 mm
Pkg. of 100 pins

Size	000	00	0	1	2	3	4	5	6	7
Rod diameter (mm)	0.25	0.30	0.35	0.40	0.45	0.50	0.55	0.60	0.65	0.70
No. 26001	-25	-30	-35	-40	-45	-50	-55	-60	-65	-70

Etched Tungsten Micro Needles

These tungsten micro needles are drawn to a 1 micron tip and three different rod diameters are offered. Each provides lateral stability as well as minimal spring action during manipulation. The micro needles can be used with our pin holders shown on page 114.

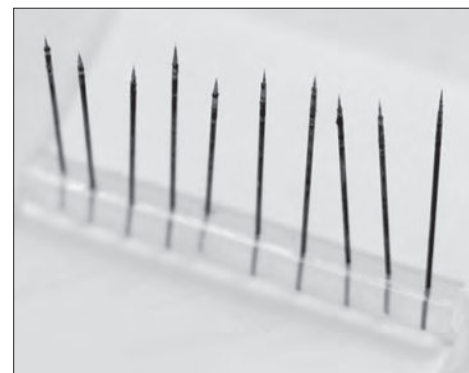

Tip diameter: 1 µm (0.001 mm)
12 mm

Box of 10 needles

Rod diameter (mm)	Item	Price
0.125	No. 10130-05	
0.25	No. 10130-10	
0.5	No. 10130-20	

NEEDLE HOLDERS

Castroviejo

Micro pattern, with slightly blunted tips.

Round Handed Needle Holder with Suture Cutter

Round handles allow easy fingertip adjustments.

Round Handed Needle Holder

Round handles allow easy fingertip adjustments.

Cautionary note: Never use a micro needle holder with needles that are too thick, as this can easily damage the fine jaws. Use only micro needles of less than 0.2 mm diameter (see page 122).



Straight

9 cm

With lock
No. 12060-01

Without lock
No. 12060-02



Curved

9 cm

With lock
No. 12061-01

Without lock
No. 12061-02



Curved
Cutting edge: 3.5 mm

14 cm

Without lock
No. 12075-14



Straight

12.5 cm

With lock
No. 12075-12

Without lock
No. 12076-12



Curved

12.5 cm

Without lock
No. 12074-12

WOUND CLOSURE

Mathieu

Extra slim and narrow profile, with squeeze-lock.
Facilitates excellent wrist motion for suturing.

**TUNGSTEN
CARBIDE**

For more information
see page 211.



14 cm

With lock
No. 12010-14



With tungsten
carbide jaws
14 cm

With lock
No. 12510-14

Castroviejo with Tungsten Carbide Jaws

**TUNGSTEN
CARBIDE**

For more information
see page 211.



With tungsten carbide jaws
14 cm

With lock
No. 12565-14

WOUND CLOSURE

Halsey

MOST POPULAR

TUNGSTEN CARBIDE

For more information see page 211.



13 cm
Smooth
With lock

No. 12001-13



13 cm
With tungsten carbide jaws
With lock

No. 12501-13

Halsey with Tungsten Carbide Jaws

TUNGSTEN CARBIDE

For more information see page 211.



12.5 cm
With tungsten carbide jaws
With lock

No. 12500-12

WOUND CLOSURE

Olsen-Hegar with Suture Cutter

MOST POPULAR

LEFT HANDED 

12102-12



12 cm
10 mm cutting edge
With lock

No. 12002-12

No. 12102-12

14 cm
15 mm cutting edge
With lock

No. 12002-14

Olsen-Hegar with Suture Cutter and Tungsten Carbide Jaws

TUNGSTEN CARBIDE

LEFT HANDED 

12512-12

For more information see page 211.



12 cm
With tungsten carbide jaws
10 mm cutting edge
With lock

No. 12502-12

No. 12512-12

14 cm
With tungsten carbide jaws
15 mm cutting edge
With lock

No. 12502-14

WOUND CLOSURE

Crile-Wood

**TUNGSTEN
CARBIDE**

For more information
see page 211.

**LEFT
HANDED** 

12504-15



15 cm
With lock

No. 12003-15



15 cm
With tungsten
carbide jaws
With lock

No. 12503-15

No. 12504-15

Mayo-Hegar



16 cm
With lock

No. 12004-16



18 cm
With lock

No. 12004-18

WOUND CLOSURE

**Slim Elongated Needle Holder
with Tungsten Carbide Jaws**

**TUNGSTEN
CARBIDE**

For more information
see page 211.



15 cm
With tungsten
carbide jaws
With lock

No. 12005-15

Ryder Mini-Select Needle Holder

This needle holder has been uniquely fashioned with tungsten carbide dust tips, giving the clamping platform an extra secure grip.

**TUNGSTEN
CARBIDE**

For more information
see page 211.



15 cm
With tungsten
carbide dust tips
With lock

No. 12505-15

WOUND CLOSURE

Microsurgical Needles with Suture Thread Attached

The combination of proprietary needle design technology and state-of-the-art manufacturing techniques has enabled S&T to provide a microsurgical needle that is unmatched in the industry. S&T microsurgical needles provide frictionless tissue penetration. They are inspected under the microscope at critical stages during the manufacturing process, and a multi-point final inspection of each suture and needle combination ensures a high quality product. The suture-to-needle attachment is tested to higher standards than the USP specifications.

Features:

- Needle and thread combination comprising of non-absorbable black nylon polyamide monofilament thread and stainless steel 3/8 circle needle. Nylon is suitable for closing ophthalmic, neurological and microvascular wounds.
- 3/8 circle precision taper point. Stainless steel needle honed under microscope by hand. Superfine round tip with flattened body to improve stability in needle holder. Easy penetration. Precise stitch placement.
- Grinding geometry and suture needle attachment are directed toward frictionless tissue penetration.
- Each needle suture combination is individually packed and sealed in a peel-open blister pack.



400% of actual size

No. 12051-11



No. 12051-10



No. 12051-08

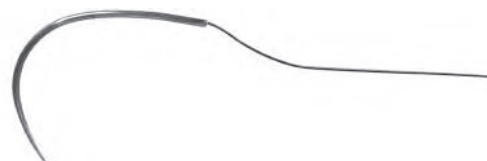

Sterile

Pkg. of 12 disposable units

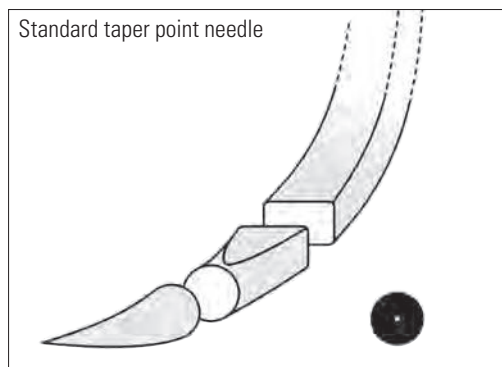

WOUND CLOSURE



Suture size	Suture length (cm)	Needle diameter (micron)	Needle diameter (mm)	Needle chord length (mm)	Circle	Arch (mm)	Item	Price
11/0	10	50	0.05	3	3/8	3.8	No. 12051-11	
10/0	10	70	0.07	3	3/8	3.8	No. 12051-10	
8/0	15	140	0.14	5	3/8	6.4	No. 12051-08	



Suture size	Suture length (cm)	Needle diameter (micron)	Needle diameter (mm)	Needle chord length (mm)	Circle	Arch (mm)	Item	Price
11/0	10	50	0.05	3.8	3/8	3.8	No. 12052-11	
10/0	10	70	0.07	3.8	3/8	3.8	No. 12052-10	
9/0	15	100	0.1	5	3/8	5.1	No. 12052-09	
8/0	15	140	0.14	5	3/8	6.4	No. 12052-08	

Suture Needles

Polished stainless steel
 3/8 curved
 Round with standard eye
 Diameter 0.35 mm
 Suitable for sutures up to 0.32 mm diameter

Non-sterile

Pkg. of 12 needles

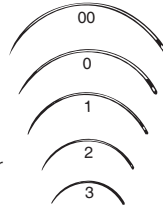

Size	Item	Price
00	No. 12050-20	
0	No. 12050-10	
1	No. 12050-01	
2	No. 12050-02	
3	No. 12050-03	

Silk Suture

Silk suture has a smooth flow through tissue while maintaining knot security.

Braided silk

Non-sterile

Can be ETO sterilized



Size	Diameter (mm)	Spool length (m)	Item	Price
7/0	0.05	91	No. 18020-70	
6/0	0.08	23	No. 18020-60	
5/0	0.12	23	No. 18020-50	
4/0	0.17	23	No. 18020-40	
3/0	0.22	23	No. 18020-30	
2/0	0.32	23	No. 18020-20	
0	0.37	23	No. 18020-00	
1	0.45	23	No. 18020-01	
2	0.55	23	No. 18020-02	
3	0.65	23	No. 18020-03	

For Suture Tying Forceps, see pages 81, 82 and 83.

Nylon Monofilament Suture

Nylon is known for its uniform diameter flexibility and outstanding consistent knot security.

Nylon monofilament

Non-sterile

Can be ETO sterilized



Size	Diameter (mm)	Spool length (m)	Item	Price
8/0	0.04	91	No. 18030-80	
7/0	0.05	91	No. 18030-70	
6/0	0.07	91	No. 18030-60	
5/0	0.10	91	No. 18030-50	
4/0	0.15	91	No. 18030-40	
3/0	0.20	91	No. 18030-30	

WOUND CLOSURE

Suturing Principles and Techniques in Laboratory Animals

Introduces the basic principles, materials and surgical instruments required for suturing and wound closure used on animals. The manual provides descriptions and pictures portraying proper tissue handling and aseptic technique, correct hand placement and use of surgical instruments, proper needle placement on needle holders, and provides an in-depth explanation of various suture patterns and associated principles for proper knot tying during wound closure.

The DVD provides descriptive narrative and step-by-step video demonstrations for each of the suturing techniques.

Manual and DVD



Includes: Fine Science Tools Item Number Reference Page for all surgical instruments used in the manual.

No. 23005-10

WOUND CLOSURE

Michel Suture Clips

Anti-magnetic, acid-resistant stainless steel
Pkg. of 1.000 clips

Size (mm)	Item	Price
7.5 x 1.75	No. 12040-01	
11 x 2	No. 12040-02	
12 x 2.5	No. 12040-03	

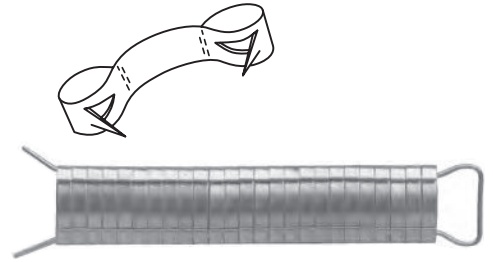

Applying Forceps



12.5 cm
For clip sizes 12040-02 and 12040-03

No. 12018-12

Applying and Removing Instruments



Curved

13 cm
For clip sizes 12040-02 and 12040-03

No. 12028-12

Angled

13 cm
For clip size 12040-01

No. 12029-12

WOUND CLOSURE

Reloadable Skin Stapler with Rotating Head

The 360° degree swivel nose and unique design offers maximum visibility at the delivery point. The stainless steel staples are non-sterile and feature a patented staple design which make for quick and easy removal. The disposable staple cartridge includes a printed staple counter. **The handle is reusable and autoclavable. Staples are non-sterile. Components sold separately or as a kit.**

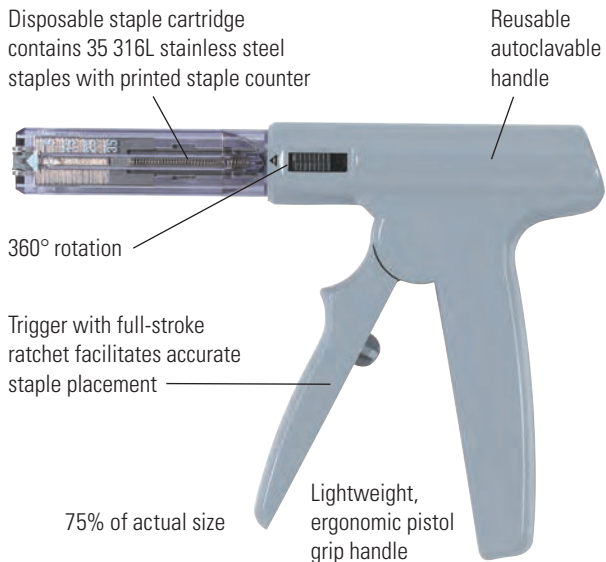

Surgical staple kit

- 1 Handle
- 1 Remover
- 12 Disposable staple cartridges

No. 12030-20

Single disposable cartridge

35 staples per cartridge
No. 12030-22

12 disposable cartridges
35 staples per cartridge
No. 12030-23

Handle
No. 12030-01

Surgical Staple Remover

Compatible with Reloadable Skin Stapler with Rotating Head and Manipler® Skin Stapler.



10 cm
No. 12030-04

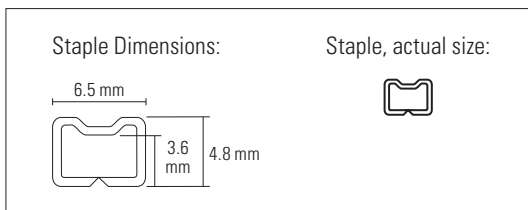

WOUND CLOSURE

Manipler® Skin Stapler

Quality, slim, lightweight design with consistent actuation and staple count indicator. **Disposable, sterile, and not autoclavable.**

15 cm
35 staples per cartridge
No. 12035-00

NOT AUTOCLAVABLE

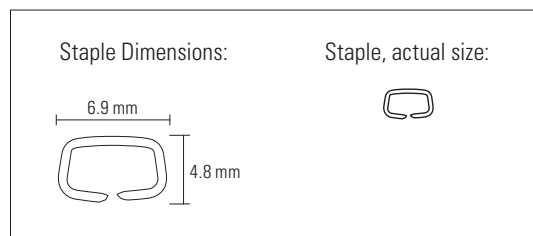

AutoClip® System

The AutoClip® System is a safe, secure method of wound closure. Faster and easier than suture, this system is perfect when staples may be too thin to provide adequate closure. **Non-sterile. Components sold separately or as a kit.** We recommend using wet steam sterilization at 120 – 125°C for at least 30 minutes in an autoclave to sterilize the device.

MOST POPULAR

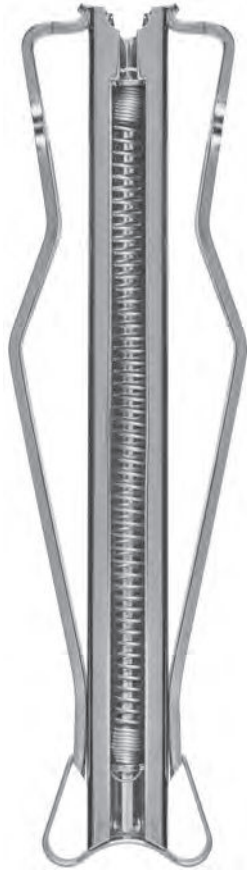

Applier



Clips



Remover

WOUND CLOSURE

- AutoClip® Kit
- 1 Applier
 - 9 mm clips (100)
 - 1 Remover
 - Storage case

No. 12020-00

AutoClip® applier
11.5 cm

No. 12020-09

AutoClip® clips
9 mm
Pkg. of 100 clips

No. 12022-09

AutoClip® clips
9 mm
Pkg. of 1000 clips

No. 12022-19

AutoClip® remover
12.5 cm

No. 12023-00

RETRACTORS

Guthrie

Extra delicate pattern.



2.5 mm



13 cm
2 Pronged
Blunt

No. 17021-13

Fine Retractor



6 mm



13.5 cm
2 Pronged
Blunt

No. 17023-13

Blair



6 mm



13.5 cm
4 Pronged
Blunt

No. 17022-13

Fomon



80% of
actual size

13 mm



17 cm
2 Pronged
2 mm Ball at each tip

No. 17020-17

Slide Retractor with Blades



2 cm
Maximum spread: 1 cm
Atraumatic blades

No. 17004-03

Mini-Goldstein

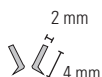

2 cm
Maximum spread: 0.5 cm
3x3 Sharp teeth

No. 17002-02

Mini-Colibri



2 cm
Maximum spread: 1 cm

No. 17000-01

RETRACTORS

Slide Retractor with Teeth



2 cm
Maximum spread: 1 cm
2x2 Blunt teeth

No. 17005-03

Goldstein

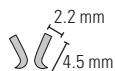
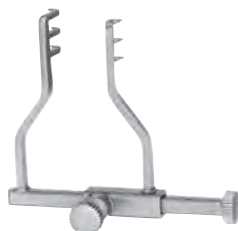

3 cm
Maximum spread: 1.8 cm
3x3 Sharp teeth

No. 17003-03

Colibri

MOST POPULAR

17000-03

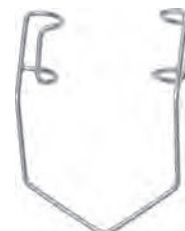

3 cm
Maximum spread: 1.5 cm

No. 17000-03

4 cm
Maximum spread: 1.5 cm

No. 17000-04



3 cm
Maximum spread: 1.2 cm

No. 17000-02

Speculum

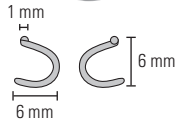

Moria 7699

4.5 cm
Maximum spread: 3.5 cm
Thin, curved blades and grooved finger grips

No. 17370-53

Fine Adjustable Wire Retractor

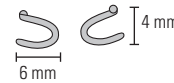

5 cm
Maximum spread: 3.5 cm
Thin, curved blades

No. 17004-05

Colibri

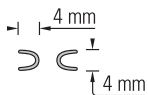

Moria 6346D

3.4 cm
Maximum spread: 1.5 cm

No. 17300-02

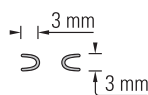

Moria 6346C

3.3 cm
Maximum spread: 1.5 cm

No. 17300-03

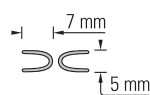

Moria 6346B

3.5 cm
Maximum spread: 2 cm

No. 17300-04

Agricola

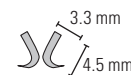

4 cm
Maximum spread: 3.5 cm
3x3 Sharp teeth

No. 17005-04

RETRACTORS

**Alm Retractor
with Wire Teeth**

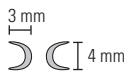

7 cm
Maximum spread: 4 cm
Arms gently curved down

No. 17010-07

**Alm Retractor
with Blunt Teeth**

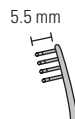

7 cm
Maximum spread: 4 cm
Arms gently curved down

Blunt teeth
No. 17008-07

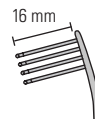

7 cm
Maximum spread: 4 cm
Arms gently curved down

Long blunt teeth
No. 17009-07

**Alm Retractor
with Blades**

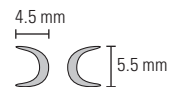

7.5 cm
Maximum spread: 4.5 cm
Arms gently curved down
Thin, curved blades

No. 17009-08

RETRACTORS

Spring-Loaded Retractor

Curved atraumatic blades

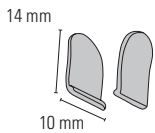

5.5 cm
Maximum spread: 3 cm
Blade dimensions: 14 x 10 mm

No. 17006-05

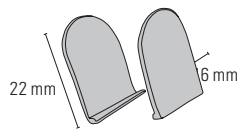

8 cm
Maximum spread: 4 cm
Blade dimensions: 22 x 16 mm

No. 17007-08

Bowman

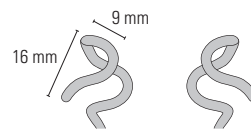

8 cm
Maximum spread: 2.5 cm

No. 17001-07

Heiss

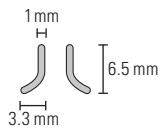

Maximum spread: 2.3 cm
 4x4 Blunt teeth
 10 cm

No. 17011-10

Gelpi

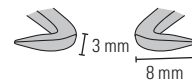

Maximum spread: 3 cm
 Angled down
 1x1 Sharp teeth
 10 cm

No. 17017-10

Weitlaner-Locktite

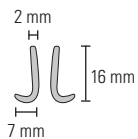
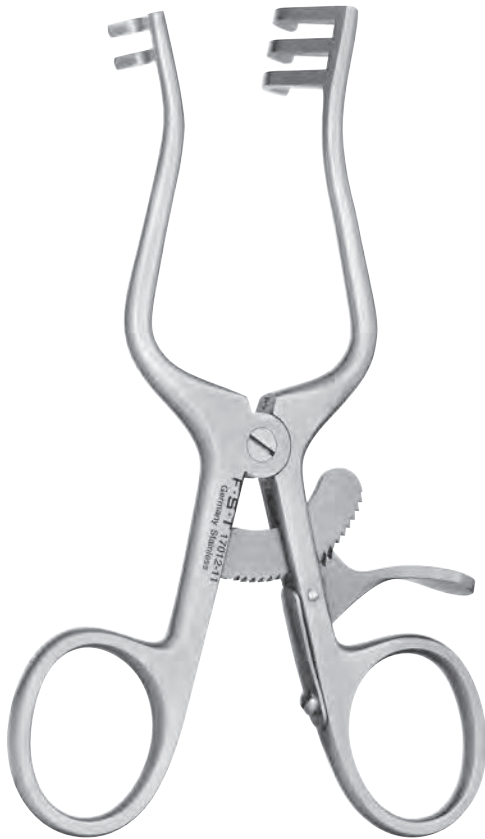

2x3 Blunt teeth
11 cm
Maximum spread: 4.5 cm
No. 17012-11

3x4 Blunt teeth
13 cm
Maximum spread: 6.5 cm
No. 17012-13

Wullstein

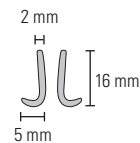

Angled down
3x3 Blunt teeth
11 cm
Maximum spread: 4.5 cm
No. 17018-11

RETRACTORS

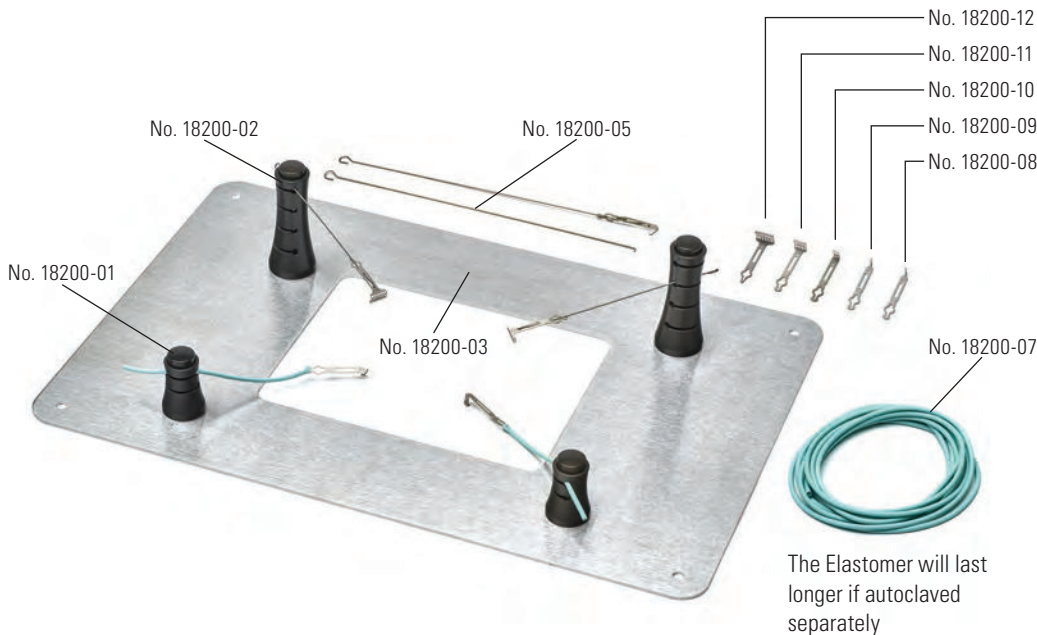

Magnetic Fixator Retraction System

This Small Animal Retraction System simplifies set-up procedure and provides the examiner with an excellent overview of the operative site. It consists of three components: Base Plate (Nos. 18200-03 & 18200-04); Fixators (Nos. 18200-01 & 18200-02); and Retractors (Nos. 18200-05 through 18200-12).

The Base Plates are made from magnetic stainless steel and are available in two sizes. The surface is nonreflective and both plates have a window in the center which allows the animal contact with body temperature control systems. The window sizes are 10 x 13 cm for the small base plate and 15 x 25 cm for the large.

The Fixators are movable anchors made from anodized aluminum with a surgical grade rare earth magnet in the base for attachment anywhere on the Base Plate. The magnets do not interfere with lab electronics and can be used in close proximity (3 cm) to ferro-magnetic items. They incorporate pushbutton-activated spring locks that grip either the Wire or Elastomer Retractors.

The Retractors are interchangeable Retractor Tips (Nos. 18200-08 through 18200-12) which attach to either Retractor Wire (Nos. 18200-05 & 18200-06) for static retraction or to Elastomer (No. 18200-07) for dynamic retraction. The Retractor Tips are light and atraumatic to delicate tissue or membrane.

All system components are autoclavable.

Kit for animals up to 200 g

Includes:

- 1 Small base plate (No. 18200-03)
- 2 Short fixators (No. 18200-01)
- 1 Tall fixator (No. 18200-02)
- 1 Elastomer, 2 m roll (No. 18200-07)
- 1 Package of retractors, blunt, 1 mm wide (No. 18200-09)
- 1 Package of retractors, blunt, 2.5 mm wide (No. 18200-10)

No substitutions

No. 18200-20

Kit for animals from 200 g up to 5 kg

Includes:

- 1 Large base plate (No. 18200-04)
- 2 Short fixators (No. 18200-01)
- 2 Tall fixators (No. 18200-02)
- 1 Elastomer, 2 m roll (No. 18200-07)
- 1 Package of retractors, blunt, 2.5 mm wide (No. 18200-10)
- 1 Package of retractors, blunt, 5 mm wide (No. 18200-11)

No substitutions

No. 18200-50

Individual parts:

Short fixator, 3 cm high
Each

No. 18200-01

Tall fixator, 6 cm high
Each

No. 18200-02

Small base plate, (20 x 30 cm)
Each

No. 18200-03

Large base plate, (25 x 35 cm)
Each

No. 18200-04

Wire handles, 10 cm long
Pkg. of 10

No. 18200-05

Wire handles, 14 cm long
Pkg. of 10

No. 18200-06

Elastomer, 2 m roll
No. 18200-07

Sharp retractors, 1 mm wide
Pkg. of 10

No. 18200-08

Blunt retractors, 1 mm wide
Pkg. of 10

No. 18200-09

Blunt retractors, 2.5 mm wide
Pkg. of 10

No. 18200-10

Blunt retractors, 5 mm wide
Pkg. of 10

No. 18200-11









Blunt retractors, 7.5 mm wide
Pkg. of 10

No. 18200-12

Clamp Size and Clamp Pressure

Clamp pressure is determined by the closing force of the clamp (in grams), divided by the area of the vessel wall that is compressed between the jaws (in square millimeters). Thus, the smaller the vessel, the higher the pressure exerted.

Despite the wide range of closing forces, the pressure exerted by each clamp, big or small, remains consistent throughout the series. Each size of clamp exerts a pressure of 5g/mm² when used on the largest vessel in its range, and 15g/mm² when used on the smallest vessel. Even at the higher range, S&T's micro clamps have the gentlest working pressure of any small vessel clamp available.

Clamp (ea)	L x W (mm)	Vessel Diameter Range (mm)
00396-01 & 18040-11	3.5 x 1.0	0.4 - 1.0  
00398-02 & 18040-22	5.5 x 1.5	0.6 - 1.5  
00400-03 & 18040-33	7.5 x 1.75	1.0 - 2.25  
00325-00	10 x 2.15	2.0 - 5.0  

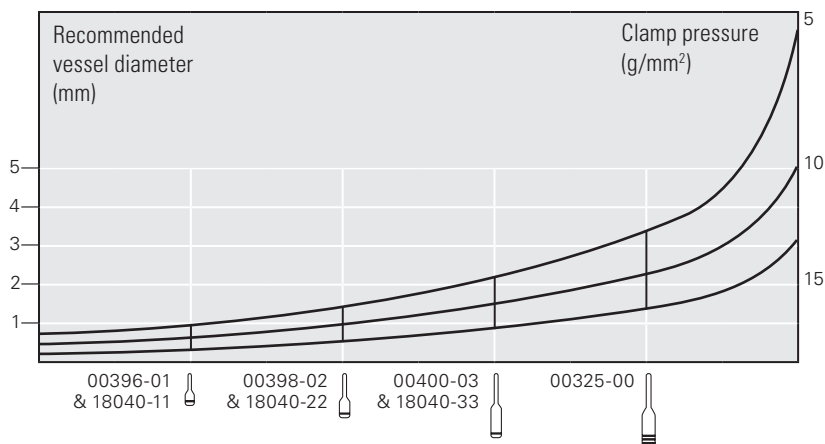

VASCULAR INSTRUMENTS

Micro Clamps
S&T®



S&T B-1
No. 00396-01



S&T B-2
No. 00398-02



S&T B-3
No. 00400-03



S&T HD-S
No. 00325-00

Double Micro Clamps

For vascular approximation at anastomosis. These clamps are mounted on a 10 mm sliding bar and can easily be moved by applying gentle force. The distance between the jaws of the clamps is adjustable from 3 to 16 mm.



No. 18040-11



No. 18040-22



No. 18040-33

Micro Clamp Applying Forceps

S&T®



14 cm
Only compatible with
S&T Micro Clamps

With lock
No. 00071-14

Without lock
No. 00072-14

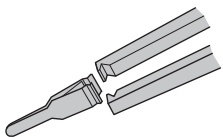

Micro Clamp Applying Forceps



14.5 cm
Compatible with S&T
Micro Clamps and
Double Micro Clamps

Without lock
No. 18040-14

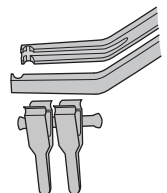
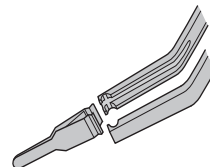

VASCULAR
INSTRUMENTS

CLAMPS

Micro Clip Applicator with Lock

MOST POPULAR



14 cm
For use with our 18055 and 18555 series micro serrefines

With lock
No. 18056-14

Forceps Style Clip Applicator

This applicator features special U-shaped side supports for improved seating of the clips.

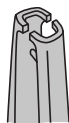

14 cm
For use with our 18055 and 18555 series micro serrefines

Without lock
No. 18057-14

Stainless Steel Micro Serrefines

Used to obtain a clear surgical field for extended arterial cross-clamping.

MOST POPULAR

Delicate atraumatic serrations
Spring width: 2 mm



	No. 18055-01	-02	-03	-04
Jaw length (mm)	10	8	6	4
Jaw width (mm)	2	2	1	0.75
Total length (mm)	19	16	15	13
Jaw pressure (g)	60	85	100	125



	No. 18055-05	-06
Jaw length (mm)	6	4
Jaw width (mm)	1	0.75
Total length (mm)	17	16
Jaw pressure (g)	100	125

Titanium Micro Serrefines

TITANIUM

Lightweight with strong clamping pressure.

For more information see page 211.

Delicate atraumatic serrations
Spring width: 2 mm



	No. 18555-01	-02	-03	-04
Jaw length (mm)	10	8	6	4
Jaw width (mm)	2	2	1	0.75
Total length (mm)	19	16	15	13
Jaw pressure (g)	60	85	100	125

Cautionary note: Micro Serrefines should never be compressed with fingers; use only the appropriate applicator No. 18056-14 or No. 18057-14.

VASCULAR INSTRUMENTS



Moria Vessel Clamp

Straight
33 mm
Finely serrated (atraumatic)
Light pressure
For vessels up to 2 mm in diameter
Calibrated to 15g/mm²
Jaw dimensions 13 x 1.6 mm



Moria 201/A

No. 18320-11

Moria Bulldog Type Clamps

53 mm
Non-serrated
Strong pressure
Jaw dimensions 16 x 2.5 mm



Straight
Moria MC43

No. 18374-43



Curved
Moria MC44

No. 18374-44

Bulldog Artery Spring Clamp

Can be used with a minimum of distortion for MRI investigations.

TITANIUM

For more information see page 211.

Straight
30 mm
Serrated
Light pressure



No. 18144-30

Dietrich Bulldog Clamps

Serrated
Good access to deep seated vessels
Closing pressure: 50 g (light)
Weight: 3 g



Straight
52.5 mm

No. 18038-45



Angled
50 mm

No. 18039-45

Bulldog Type Serrefines

Serrated

Straight
28 mm
Medium pressure



No. 18050-28

Curved
28 mm
Medium pressure



No. 18051-28



Straight
35 mm
Strong pressure

No. 18050-35

Straight
50 mm
Strong pressure

No. 18050-50

MOST POPULAR
Curved
35 mm
Strong pressure

No. 18051-35



Curved
50 mm
Strong pressure

No. 18051-50

Schwartz Micro Serrefines

Non-serrated
Strong pressure
26 mm

MOST POPULAR

Straight



No. 18052-01

Light bend



No. 18052-02

Sharp bend



No. 18052-03

Biemer Clip

Serrated
Straight
Closing Pressure: 30 g - 40 g (light)

15 mm
Clamping Length: 6 mm

NEW ITEM

No. 18058-15



18 mm
Clamping Length: 9 mm

No. 18058-18



Mini Serrefines

28 mm
Smallest bulldog-type hemostatic clamps
Medium pressure
Gentle serrations
2 mm wide

Straight



No. 18054-28

Curved



No. 18053-28

LIGATION SYSTEM

Horizon™ Metal Ligation System

The Horizon™ System provides surgeons with a strong, secure clip coupled with an efficient, convenient easy-load cartridge system. The preformed chevron shape of the Horizon™ Clip engulfs tissue with precise tip-to-tip closure. Heart-shaped wire is designed to give each clip a firm grip on vessels, while the triangulated cross-section of the clip leg maximizes surface-to-surface contact between clip and jaw, practically eliminating clip fallout.

VASCULAR
INSTRUMENTS



Clips

Horizon™
Ligation Clips

1.98 x 2.87 mm
Pkg. of 6 Clips
Sterile

No. 18070-10

Remover

Horizon™
Clip Remover

Straight
16.5 cm

No. 18073-00



Applicator

Horizon™
Ligation Applicator

Curved
20 cm

No. 18070-00

Silver Neuro Clips

These single-use, silver neuro clips are meant for permanent vessel occlusion.

Pkg. of 100 clips
No. 18040-00



VASCULAR INSTRUMENTS

Vascular Occluders

Applications

- Fast, dependable zero-flow baseline determination in blood flow studies.
- Partial to full occlusion of vessels for circulation research studies.
- Prolonged implantations, such as chronic blood flow studies.
- Constriction of soft organs in acute or chronic applications.

Operation

- Step 1** Apply the occluder cuff around the exposed blood vessel. Secure it in place with suture material through the eyelets.
- Step 2** Occlude the vessel to the desired degree by inflating the diaphragm with air or liquid injected into the actuating tube using a syringe and blunt needle. Clamp the tubing to maintain occlusion of the vessel over time.
- Step 3** To deflate, simply withdraw the air or liquid.

Benefits

- Occlusion is accomplished without traction on vessels or surrounding tissues.
- The actuating tube may be exteriorized from the occlusion site for remote actuation.
- Performance during implantations is reliable and consistent.
- Autoclavable or cold sterilized, and easily maintained.
- Made from soft, flexible 100% silicone rubber.
- Fully operational with instant response using air, liquids, or inert gases.

Selection

The lumen diameter when deflated is usually the determining factor in the selection of the proper device. Select the occluder size that provides a slightly loose fit around the subject vessel. The cuff width and thickness will vary, depending on models and sizes.

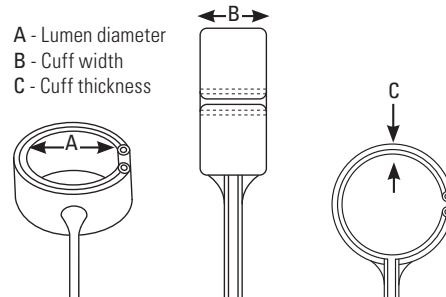

The actuating tube length is 90 cm and measures 0.76 mm ID x 1.6 mm OD. Detailed instructions are included.

VO-1.5 N

Lumen diameter: 1.5 mm
Cuff width: <3.5 mm
Cuff thickness: 1.5 mm

No. 18080-01

VO-2

Lumen diameter: 2 mm
Cuff width: 5 mm
Cuff thickness: 1.5 mm

No. 18080-02

VO-3

Lumen diameter: 3 mm
Cuff width: 5 mm
Cuff thickness: 1.5 mm

No. 18080-03

Vessel Dilators

Highly modified forceps with elongated, parallel tips which are highly polished. Designed for controlled intraluminal vessel dilation.

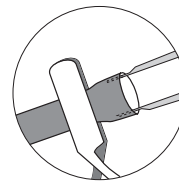

S&T®

S&T®



Angled 10°

11 cm
Tip diameter: 0.1 mm

No. 00126-11

Tip diameter: 0.2 mm

No. 00125-11

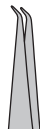

Angled 45°

13.5 cm
Tip diameter: 0.2 mm

No. 00276-13



Angled 10°

12 cm
Tip diameter: 0.1 mm

No. 18131-12

Tip diameter: 0.2 mm

No. 18132-12

V-Hook

Aids in feeding fine suture around blood vessels, works very similar to ligation aids.



300%



11 cm
Tip diameter: 0.4 x 0.2 mm

No. 18052-12

Ligation Aids

A handy instrument for leading a fine suture under and around a blood vessel for tying-off purposes. Also useful for ligating peripheral nerves. Grooves toward hole help threading.



18063-13



300%

Ultrafine



10.5 cm
Hole diameter: 0.4 mm

No. 18062-12



200%

200%



13.5 cm
Hole diameter: 1 mm

No. 18062-13



13.5 cm
Hole diameter: 1 mm

No. 18063-13

VASCULAR INSTRUMENTS

Micro Cannulation System

This micro cannula is most helpful for quick and easy insertion in arteries and veins. It can be used as an “indwelling” catheter during long term experiments. With care, thorough rinsing and sterilization, it can be reused several times. Detailed instructions are included.



Features

- Biocompatible Teflon® tubing.
- Cannula size 0.33 mm OD – 0.16 mm ID
- A pointed stainless steel stylus (trocar), to aid in vascular penetration and allow a maximum range of cannula manipulation during insertion.
- Contoured tip for easy insertion, fitted with shoulder for “tie-in” to prevent accidental removal.
- Female luer connection for linkage to infusion lines.

MOST
POPULAR

1 Approach
Cannulation Forceps (Item No. 18403-11) and Spinal Cord Hook (Item No. 10162-12) aid in the insertion process.

2 Insertion
Remove trocar and advance cannula.

3 Secure
Use shoulder hub and suture to “tie in” cannula to prevent accidental removal.

Instruments sold separately.

8 cm

Cannula size 0.33 mm OD - 0.16 mm ID

No. 18000-10

Vessel Cannulation Forceps

These vessel cannulation forceps are useful whenever a fine plastic tube has to be introduced into a small blood vessel of almost equal size. The hollowed jaws hold the tubing securely without deforming it. The tip of the tubing is directed exactly into the vessel opening without damage to the vessel from unwanted movement.

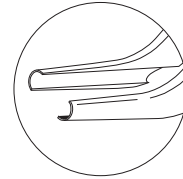

11 cm
For tubing of 0.35 mm OD

No. 00608-11

11 cm
For tubing between
0.5 and 1 mm OD

No. 00574-11



11 cm
For tubing of 0.35 mm OD

No. 11280-11

11 cm
For tubing of 0.5 mm OD

No. 11281-11

11 cm
For tubing of 1 mm OD

No. 11282-11



11.5 cm
For tubing of 0.35 mm OD

No. 18403-11

11.5 cm
For tubing of 0.6 mm OD

No. 18406-11

13.5 cm
For tubing of 0.6 mm OD

No. 18406-13

VASCULAR INSTRUMENTS

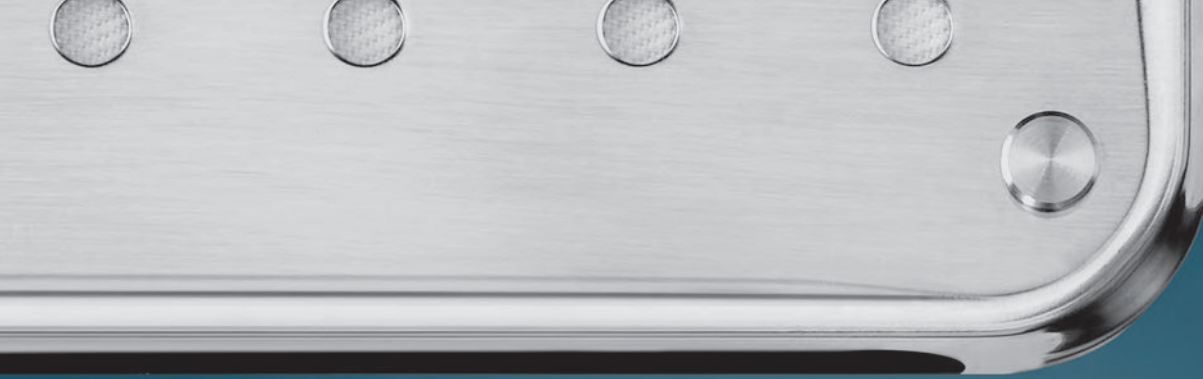

Accessories & Instrument Care

Animal Accessories	Pages	147 – 152
Instrument Care & Accessories	Pages	153 – 166
Surgical Accessories	Pages	167 – 170
Laboratory Accessories	Pages	171 – 183



Reusable Gavage Feeding Needles

Stainless steel feeding needles with luer lock hub. Also ideal for transcardiac perfusions with a fixative.

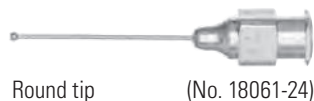

Gauge	Length (mm)	Tip diameter (mm)	Shape	Mice	Rats	Guinea pigs	Item	Price
24	25	1.25	Straight	>14 g			No. 18061-24	
22	25	1.25	Straight	15-20 g			No. 18061-22	
20	30	Barrel	Straight	20-25 g	50-75 g		No. 18060-20	
20	38	2.25	Straight	20-25 g	50-75 g		No. 18064-20	
20	38	2.25	Curved	20-25 g	50-75 g		No. 18065-20	
18	38	2.25	Straight	20-30 g	100-200 g	250-300 g	No. 18061-38	
18	50	2.25	Curved	25-30 g	100-200 g	250-300 g	No. 18061-50	
16	75	3.00	Curved		150-300 g	350-450 g	No. 18061-75	
16	100	3.00	Curved		150-300 g	350-450 g	No. 18061-10	

Single Use Gavage Feeding Needles

These economical feeding needles feature plastic luer hubs with silicone tips. They are nontoxic and nonpyrogenic. Needles can be easily formed to any desired shape. **Sterile.**

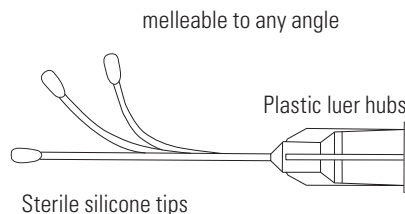

Pkg. of 5 needles

Gauge	Length (mm)	Tip diameter (mm)	Shape	Mice	Rats	Guinea pigs	Item	Price
20	38	1.75	Flexible	20-25 g	50-75 g		No. 18061-20	
18	50	2.50	Flexible	25-30 g	100-200 g		No. 18061-18	
15	75	3.00	Flexible		200-350 g	400-600 g	No. 18061-15	

ANIMAL ACCESSORIES

Disposable Flexible PTFE Feeding Needles

These affordable needles feature flexible PTFE tube with silicon tip and plastic luer hub, delivered in sterile pouches. They are very flexible, and translucent for easy confirmation of reagent delivery. The soft silicone tips are non-toxic and non-pyrogenic and ensure that no damage occurs during the insertion. **Sterile.**

Pkg. of 5 needles

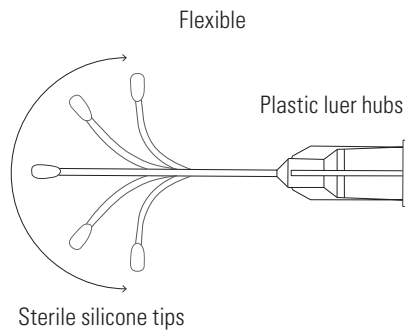

Gauge	Length (mm)	Tip diameter (mm)	Shape	Mice	Rats	Guinea pigs	Item	Price
20	38	Barrel 1.8	Flexible	20-25 g	50-75 g		No. 18961-20	
18	38	Barrel 2	Flexible	20-30 g	100-200 g	250-300 g	No. 18961-18	
17	52	Barrel 2.4	Flexible	25-30 g	100-200 g	250-300 g	No. 18961-17	
15	78	Barrel 2.6	Flexible		200-350 g	400-600 g	No. 18961-15	
18	75	Barrel 2	Flexible	25-30 g	150-250 g	250-300 g	No. 18961-75	
17	85	Barrel 2.4	Flexible	25-30 g	150-250 g	250-300 g	No. 18961-85	

GenoPunch

The interchangeable GenoPunch aids in the fast and simple collection of the 2 mm tissue sample for DNA analysis and/or genotyping. FST Exclusive Item.

Autoclavable.

MOST POPULAR



70% of actual size



GenoPunch includes:

- 1 GenoPunch
- 1 0.5 ml tube holder
- 1 1.6 ml tube holder
- 1 Screwdriver
- 4 Screws



FST does not supply microtubes.

11.5 cm
Stainless steel and anodized aluminum
Punch diameter: 2 mm

No. 24215-02

Blue Ear Punch

The Ear Puncher relieves stress on the wrist during ID marking as it requires only a very gentle pressure to cut a hole. The stainless steel puncher has a sloped edge that provides a cut rather than a punch, which minimizes animal discomfort.

Autoclavable.

NEW ITEM



14 cm
Punch diameter: 2 mm

No.24916-02

ANIMAL ACCESSORIES

EAR PUNCHS

Ear Punch with Replaceable Tip

Designed to ensure a fast and clean punch, this ear punch is lightweight and fits comfortably in the palm of your hand. The tip is replaceable. **Autoclavable.**



Handle and Tip

11.5 cm
Anodized aluminum handle
and stainless steel tip
Punch diameter: 2 mm

No. 24213-02

Replacement Tip

Punch diameter: 2 mm

No. 24213-12

Ear Punch

Designed to ensure a fast and clean punch, this ear punch is lightweight and fits comfortably in the palm of your hand. FST Exclusive Item. **Autoclavable.**



11.5 cm
Stainless steel and
anodized aluminum
Punch diameter: 2 mm

No. 24214-02

Finger Loop Ear Punch

This ear punch provides stability and control for researchers using the numbering system. The 1 mm ear punch offers greater numbering variations and/or patterns.

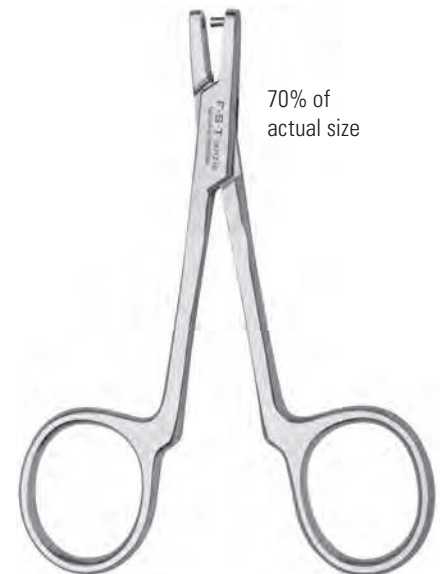

10.5 cm
Punch diameter: 1 mm

No. 24212-01

Punch diameter: 2 mm

No. 24212-02

Marking Pen

The Marking Pen was developed for easy, long lasting identification of laboratory animals. The markers contain no harmful chemicals and instead nontoxic pigment approved by the Japanese Ministry of Health for use in food, drugs and cosmetics. It is intended for use on the fur and not the skin and will last for 6-12 weeks.

CAUTION:

color can stain skin and clothing. The use of gloves and lab coats is recommended. These colours will not work on black fur.



Fine Tip
4.5 x 7.5 mm
Black
10ml

No. 24202-06



Fine Tip
4.5 x 7.5 mm
Blue
10ml

No. 24202-02



Fine Tip
4.5 x 7.5 mm
Green
10ml

No. 24202-01



Fine Tip
4.5 x 7.5 mm
Red
10ml

No. 24202-04



Fine Tip
4.5 x 7.5 mm
Yellow
10ml

No. 24202-03



Fine Tip
4.5 x 7.5 mm
Orange
10ml

No. 24202-05



Standard Tip
15 x 10 x 10 mm
Black
15ml

No. 24202-16



Standard Tip
15 x 10 x 10 mm
Blue
15ml

No. 24202-12



Standard Tip
15 x 10 x 10 mm
Green
15ml

No. 24202-11



Standard Tip
15 x 10 x 10 mm
Red
15ml

No. 24202-14



Standard Tip
15 x 10 x 10 mm
Yellow
15ml

No. 24202-13



Standard Tip
15 x 10 x 10 mm
Orange
15ml

No. 24202-15

ANIMAL ACCESSORIES

Surgical Skin Marker

This marker features a versatile tip for precise fine (0.2 mm) line marking, or when held at an angle, a broad (2 mm) line marking.

The marker's violet ink is nontoxic, non-tattooing and surgical prep-resistant. Markings can be removed from the skin with isopropyl alcohol. A six-inch ruler calibrated in both centimeters and inches is included.

14 cm

No. 18000-30



50% of actual size

Self Piercing Ear Tags

Ideal for use in small animals such as mice and rats, these ear tags come numbered from 1-100 or 1-500. Silver colored tags with black numbers provide high visibility making them easy to read. Once applied, tags seal and cannot be removed, providing an easy to use, permanent identification method. These ear tags are safe for use in salt water.



Ear tags
Alloy: Monel
7.8 x 2.8 mm

Black numbers 1-100	Black numbers 1-500	Black numbers 501-1000
No. 24220-10	No. 24220-50	No. 24220-90



Custom alphanumeric sequences and numbers above 1000 are available by special order.

1 to 6 numbers only:	1 to 6 letters and numbers:
\$50.00 per 100 ear tags	\$62.00 per 100 ear tags
\$145.00 per 500 ear tags	\$160.00 per 500 ear tags

For special order, use item No. 70000-10 and indicate sequence. Please allow 4 to 5 weeks for delivery.

Ear Tags (enlarged view)

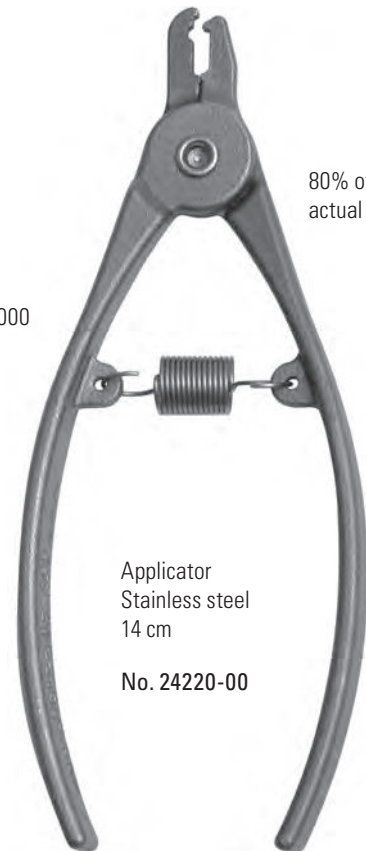

80% of actual size

Applicator
Stainless steel
14 cm

No. 24220-00

Animal Microtattoo System

A quick, efficient and affordable method of permanently identifying laboratory animals (mice as early as 1 day old). Designed and tested by laboratory animal technicians, the system utilizes a hypodermic needle at one end of a stainless steel forceps and a small metal cup containing green tattoo paste at the other side of the forceps.

By squeezing the forceps together, the needle penetrates the toe, footpad or ear of the animal and injects a deposit of green tattoo paste into the animal. A grid location pattern provided enables a numbering system that extends over 1 million.

Use of the microtattoo system is humane and in compliance with regulatory agencies for the care and use of laboratory animals. Detailed instructions are included. **Both the microtattoo forceps and green tattoo paste are autoclavable.**

Animal microtattoo system includes:

- 1 Pair plated steel microtattoo forceps
- 1 Tube (1 oz.) of green tattoo paste
- 1 Aluminum planchette
- 2 Hypodermic needles
- 1 Plastic holding case



13 cm
Animal microtattoo system

No. 24201-00
Green tattoo paste



1 oz / 29.6 ml

No. 24201-01

Silicone Seal and Lubricant

This stiff non-melting silicone base maintains its consistency from -40°C to 200°C (40°F to 392°F) with less than 2% evaporation after 24 hours of exposure to 150°C (302°F). Typical applications include lubrication of stopcock rotating parts and other lab items. Seals vacuum and low pressure systems. Compatible with glass, plastics, metals, synthetic rubber gaskets and seals. **Autoclavable.**

15 ml container

No. 29051-45



Demagnetizer

This safe and easy to operate tabletop demagnetizer has a large coil opening of 8 x 4 cm in a rigid, molded housing. Can be used to demagnetize or magnetize instruments.

12 x 5.5 x 9 cm

No. 18000-15



Instrument Sharpening Stones

Natural Arkansas oil stones feature unequalled fineness, hardness and structural density. When used with mineral oil, they will produce a sharper cutting edge.

6 mm x 9 cm

Square stone

No. 29008-01

Triangular stone

No. 29008-12

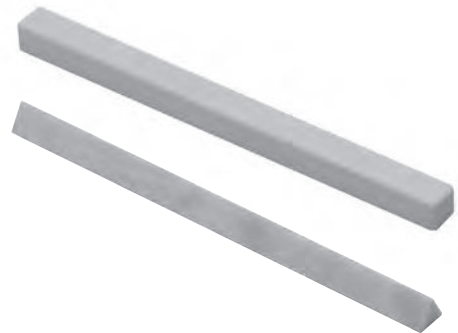

Optical Cleaning Kit and Lens Paper

This convenient kit contains everything you need to clean lens surfaces safely. Perfect for microscopes, camera lenses, binoculars, telescopes, graphic art optics, and all other fragile lenses. Storage case included.

Kit includes:

- 1 Bottle of lens cleaner (30 ml)
- 1 Ultra soft duster brush
- 1 Cleaning cloth (20 x 20 cm)
- 3 Books of lens paper (25 sheets each)

Lens Paper
15 x 10 cm
Book of 50 sheets

Kit

No. 29000-10

No. 29015-50



Sharpening Stone for Fine Forceps

This natural Arkansas stone assists in reshaping the tips of fine forceps. The stone has two grooves, 0.8 mm and 1.6 mm, and comes in a cedar box with ten O-rings.



4 x 1 x 10 cm

No. 29008-22

Instrument Oil

Physiologically inert oil for lubricating surgical instruments, box locks, ratchets and any overlapping joints.



50 ml bottle

No. 29055-00

O-Rings for Forceps

These rubber O-rings fit our forceps and keep them closed with variable degrees of pressure on the tips.



Pkg. of 10

No. 11200-00

Fine Forceps Repair Kit

Realign and repair fine forceps with this convenient kit. Bent forceps tips can be restraightened with the chain nose pliers. The sharpening stone has two grooves, 1.6 mm and 0.8 mm, to assist in reshaping the forceps tips. O-rings clamp the forceps shut to ensure that both shanks are equally aligned and sharpened. Instrument oil assists in producing a smooth sharp edge. Detailed instructions are included.

MOST POPULAR



Kit includes:

- 1 Sharpening stone for fine forceps with ten O-rings (No. 29008-22)
- 1 Instrument oil, 50 ml bottle (No. 29055-00)
- 1 Chain nose pliers

No. 29000-00

Instrument Marking Tape

Organize instruments quickly and easily with this economical, non-toxic, pressure sensitive tape. Color is unaffected by boiling, cold sterilization or autoclaving. 8 colors available.

Autoclavable.



Color	Roll size (cm)	Material	Item	Price
Green	290 x 0.6 cm	Vinyl	No. 29071-01	
Blue	290 x 0.6 cm	Vinyl	No. 29071-02	
Yellow	290 x 0.6 cm	Vinyl	No. 29071-03	
Red	290 x 0.6 cm	Vinyl	No. 29071-04	
White	290 x 0.6 cm	Vinyl	No. 29071-05	
Black	290 x 0.6 cm	Vinyl	No. 29071-06	
Brown	290 x 0.6 cm	Vinyl	No. 29071-07	
Orange	290 x 0.6 cm	Vinyl	No. 29071-08	

**Instrument Marking Tape
8 Assorted Colors**

Organize instruments quickly and easily with this economical, non-toxic, pressure sensitive tape. Color is unaffected by boiling, cold sterilization or autoclaving. Includes 8 assorted color rolls: Yellow, Red, Black, White, Green, Brown, Blue and Orange.

Autoclavable.

1 each of 8 colors above 107 x 0.6 cm (each roll) Vinyl No. 29080-00

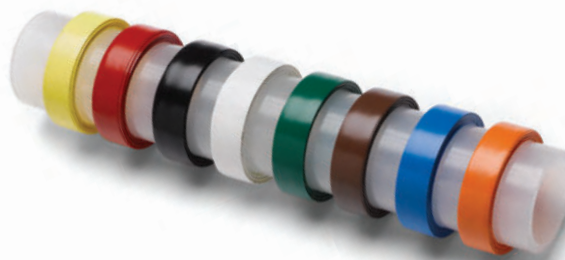

9 colors available

Organize instruments quickly and easily with this economical, non-toxic, pressure sensitive tape. Color is unaffected by boiling, cold sterilization or autoclaving. 8 colors available.

Autoclavable.



Color	Roll size (cm)	Material	Item	Price
Green	510 x 0.6 cm	Vinyl	No. 29070-01	
Blue	510 x 0.6 cm	Vinyl	No. 29070-02	
Yellow	510 x 0.6 cm	Vinyl	No. 29070-03	
Red	510 x 0.6 cm	Vinyl	No. 29070-04	
White	510 x 0.6 cm	Vinyl	No. 29070-05	
Black	510 x 0.6 cm	Vinyl	No. 29070-06	
Brown	510 x 0.6 cm	Vinyl	No. 29070-07	
Orange	510 x 0.6 cm	Vinyl	No. 29070-08	
Purple	510 x 0.6 cm	Vinyl	No. 29070-09	

INSTRUMENT CARE & ACCESSORIES

Instrument Tip Protectors

These tip protectors are a convenient, color-coded way to protect surgical instrument tips and edges. They provide exceptional protection and are vented to prevent rusting from condensation. Instrument tip protectors are recommended during handling, storage, and sterilization. **Autoclavable.**

MOST POPULAR
29060-00



1.6 x 19.1 mm
Pkg. of 25
Material: Plastisol

No. 29060-01



2 x 19 mm
Pkg. of 25
Material: Plastisol

No. 29060-02



2.8 x 19.1 mm
Pkg. of 25
Material: Plastisol

No. 29060-03



3.2 x 25.4 mm
Pkg. of 25
Material: Plastisol

No. 29060-04



4.8 x 25.4 mm
Pkg. of 25
Material: Plastisol

No. 29060-05



2 x 9.5 x 25.4 mm
Pkg. of 25
Material: Plastisol

No. 29060-06



Assorted pack, five of each size
Pkg. of 30
Material: Plastisol

No. 29060-00

INSTRUMENT CARE
& ACCESSORIES

Double Tip Protectors

These vented tip protectors are designed to hold hemostats and rongeurs firmly while allowing the jaws, box hinge and tips to stay open for thorough sterilization. **Autoclavable.**



12.7 x 20 mm
Pkg. of 10
Material: Plastisol

No. 29066-01



9 x 25.5 mm
Pkg. of 10
Material: Plastisol

No. 29066-02



15 x 25 mm
Pkg. of 10
Material: Plastisol

No. 29066-03



25 x 26 mm
Pkg. of 10
Material: Plastisol

No. 29066-04



Assorted pack, three of each size
Pkg. of 12
Material: Plastisol

No. 29066-00

Self Sealing Sterilization Pouches

Preformed pouches with self adhering tape are blue tinted on one side for visualization of contents, and paper-backed on the other side. Pouches will work with either steam autoclave or ethylene oxide sterilization.

Material properties:

- Protects instruments during sterilization.
- Provides sterile storage until use.
- Write on pouches for easier identification during sterilization.



10 x 18 cm
For instruments up to 13 cm long

Pkg. of 100 pouches

No. 28000-07

13 x 26 cm
For instruments up to 23 cm long

Pkg. of 100 pouches

No. 28000-10

18 x 30 cm
For instruments up to 26 cm long

Pkg. of 100 pouches

No. 28000-12

Hot Bead Sterilizer

The sterilizer provides a safe, effective and convenient method for sterilizing your surgical instruments prior to and during surgery or tissue culture. Without using potentially dangerous gases, flames or chemicals, you can ensure that your instruments will be free of pathogens and microbial contaminants.

The beads take 15–20 minutes to reach 240°C to 270°C (464°F to 518°F), and then the sterilizer is ready for use. The temperature is thermostatically maintained, and the unit can be left on all day. Instruments require approximately 20 seconds of contact with the beads for complete sterilization. The sterilizer is safe to use even in laminar flow hoods.

Sterilization test results conducted by the Pasteur Institute in Lille, France, are available upon request. Available in 110V and 220V. CE Certified and UL Approved.

Sterilizer includes:

- Sterilizer unit
- 1 Bag of glass beads
- 1 Dust cover for well
- 1 Small heat-tempered glass dish for small objects (only with FST 250)



FST 250 shown.
Instruments not included.

FST 250 Sterilizer

Well diameter: 4 cm
Well depth: 8 cm
Well volume: 100 ml
Total unit size: 14.5 x 12.5 x 13.5 cm

No. 18000-45

Replacement glass beads for FST 250

Weight: 150 gr

No. 18000-46

FST 350 Sterilizer

Well diameter: 4 cm
Well depth: 14 cm
Well volume: 175 ml
Total unit size: 20.5 x 12.5 x 13.5 cm

No. 18000-50

Replacement glass beads for FST 350

Weight: 300 gr

No. 18000-51

Micro Bead Sterilizer with Glass Beads

Micro Bead Sterilizer is ideal for the sterilization of small and large research tools (forceps, scissors, etc.). When the chamber is filled with the included glass beads, high temperatures (up to 300° C) can be used to eliminate the presence of bacteria, spores and other micro-organisms.

**Small Sterilizer**

110V

Well diameter: 4 cm

Well depth: 8 cm

Well volume: 100 ml

Total unit size: 13 x 14.5 x 15.5 cm

No. 18090-45

Small Sterilizer

220V

Well diameter: 4 cm

Well depth: 8 cm

Well volume: 100 ml

Total unit size: 13 x 14.5 x 15.5 cm

No. 18090-46

Replacement glass beads for small sterilizer

Weight: 150 gr

No. 18000-47

**Tall Sterilizer**

220V

Well diameter: 4 cm

Well depth: 14 cm

Well volume: 175 ml

Total unit size: 14 x 14.5 x 21.5 cm

No. 18090-51

Replacement glass beads for tall sterilizer

Weight: 300 gr

No. 18000-52



Small sterilizer shown.
Instruments not included.

Tall Sterilizer

110V

Well diameter: 4 cm

Well depth: 14 cm

Well volume: 175 ml

Total unit size: 14 x 14.5 x 21.5 cm

No. 18090-50

Autoclave Tape Dispenser

Easy loading core with heavy duty steel construction and a non-skid base. Serrated cutting blade cuts tape fast and cleanly.



Tape sold separately.

23.5 cm
Coated steel
No. 28001-00

Autoclave Tape

Tape will permanently indicate diagonal stripes after exposure to steam autoclave temperature between 121°C and 130° C during a 40-60 minute time period. Use with sterilization pouches, sterilization wraps and sterilization cases.

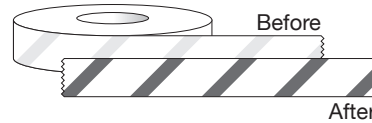

2 cm x 55 m
No. 28001-02

Disposable Sterilization Wraps

These biodegradable cellulose fiber wraps are resistant to tears and conform easily to maintain a breathable yet impervious barrier to airborne bacteria, saline, blood and water. Wrapping your instrument case securely will ensure the sterility of your instruments until ready for use. Available in two sizes.



Cases not included.

38 x 38 cm
Pkg. of 25 wraps
No. 28015-15
51 x 51 cm

Pkg. of 25 wraps
No. 28020-20

Silicone Mat

High quality, extra soft mat for safe and secure placement of delicate instruments. This mat can easily be cut along the premarked grooves to fit in various sized instrument cases. **Autoclavable.**

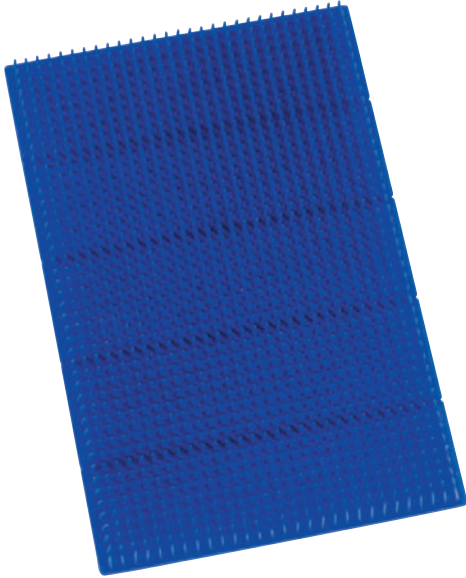

30 x 20 cm

No. 20325-00

Magnetic Sterilization Mat

Used during sterilization and for safe anti-slip placement around surgical settings. **Autoclavable.**



Instruments not included.

30 x 20 cm

No. 20350-00

Silicone Mat

Large, economical silicone mat. **Autoclavable.**

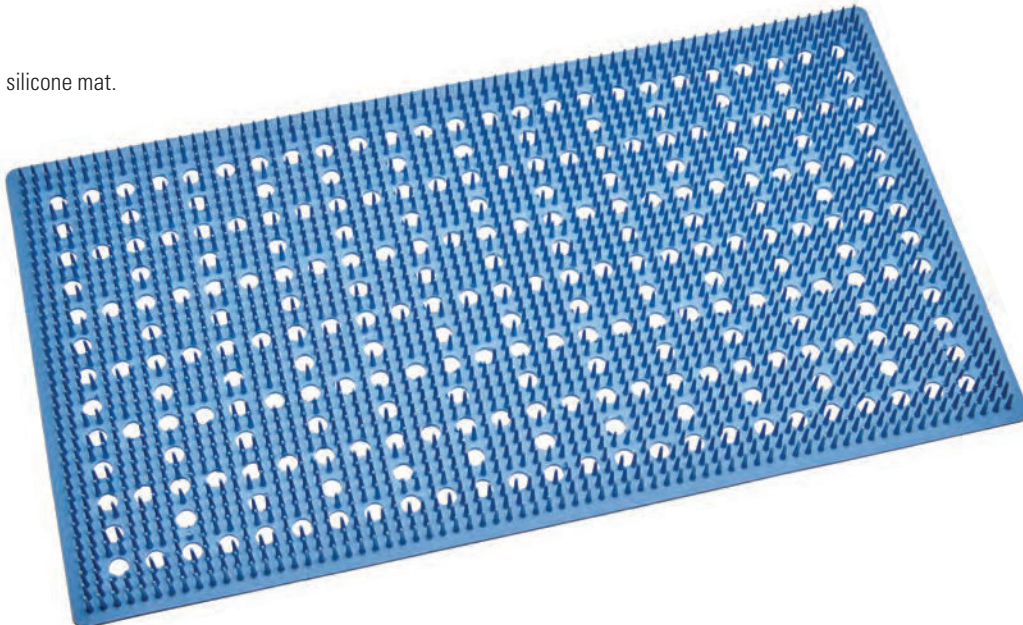

46 x 25 cm

No. 20325-10

INSTRUMENT CARE & ACCESSORIES

STERILIZATION CONTAINER

Sterilization Container

This plastic sterilization container includes a silicone mat for safe placement of instruments. Perforated top is clear for visual identification of instruments. **Suitable for autoclave or ethylene oxide sterilization.**



19 x 10 x 2 cm

No. 20810-01

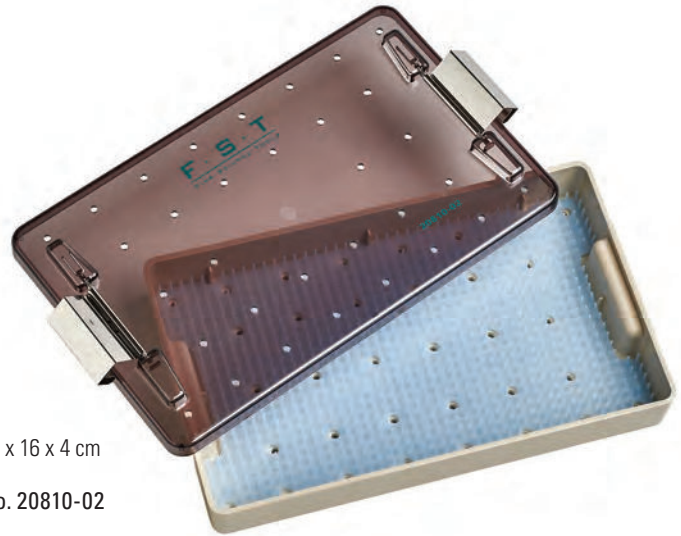

27 x 16 x 4 cm

No. 20810-02

Two Tiered Sterilization Container

This plastic sterilization container has two tiers of silicone slots that will accommodate up to 12 different instruments. Hinged top and bottom lock tight. Container is perforated. **Suitable for autoclave or ethylene oxide sterilization.**



25 x 12 x 3 cm

No. 20820-00

Sterilization Container

This sterilization container is made from Ultem® polymer to ensure strength and long lasting durability. The transparent perforated lid provides easy identification of your surgical instruments. Silicone mat is included for a safe and secure hold. Trays are also stackable for convenience. **Suitable for autoclave or ethylene oxide sterilization.**

MOST POPULAR
20840-03

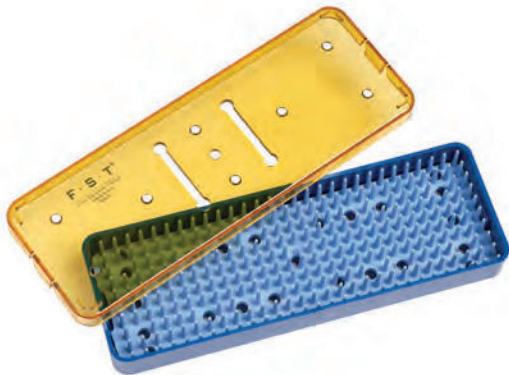

19 x 7 x 2 cm
Single tier

No. 20840-01

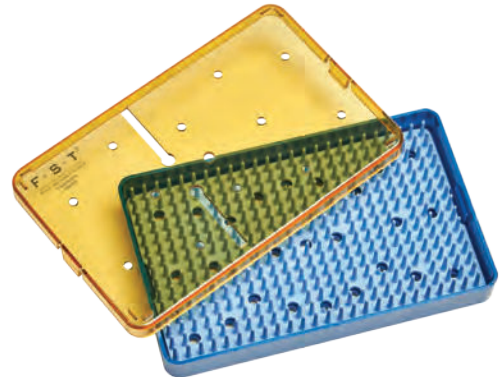

17 x 10 x 2 cm
Single tier

No. 20840-02

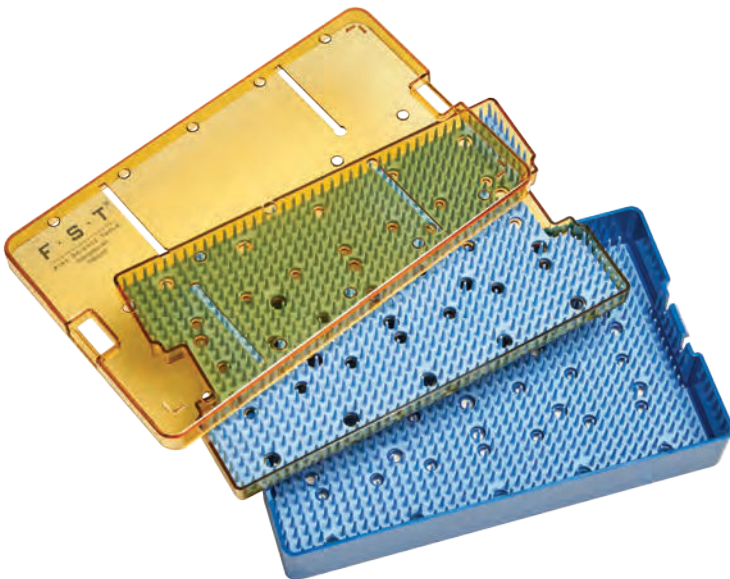

25 x 15 x 4 cm
Double tier

No. 20842-03

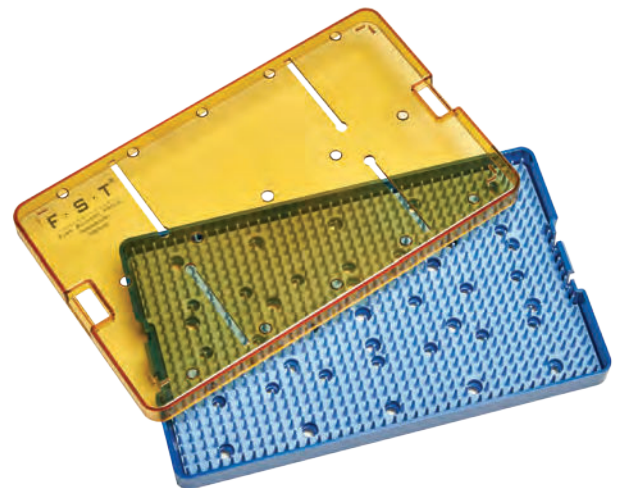

25 x 15 x 2 cm
Single tier

No. 20840-03

INSTRUMENT CARE
& ACCESSORIES

Dual Clamping Stainless Steel Sterilization Container

This container will assist in the sterilization and storage of your fine surgical instruments. It comes with a custom fit silicon mate to keep instruments in place while the sterilizing process and storage. The textile filters are necessary for keeping instruments sterile while they remain in the container.

Suitable for autoclave or ethylene oxide sterilization.



30 x 14 x 4 cm

No. 20850-00

5 Long-term textile filters
No. 20850-10

One Long-term textile filter
No. 20850-11

Stainless Steel Sterilization Container

Removable perforated interior plates hold long-term textile filters which keep the instruments sterile while they remain in the container. Lid can be locked in place. Comes with two textile filters installed. **Suitable for autoclave or ethylene oxide sterilization.**



20 x 10 x 4 cm

No. 20890-51

10 Long-term textile filters
No. 20890-72

One Long-term textile filter
No. 20890-71



Utility Instrument Case

Comes with a silicone mat for safe placement of instruments. **Case and silicone insert are autoclavable but should not be used for sterilizing surgical instruments.**



18 x 9 x 3 cm

No. 20311-21

Colored Aluminum Cases

This instrument case comes with a spiked silicone mat for secure storage of surgical instruments. Seven colors available but may vary due to lot to lot variations.

The case and silicone insert are autoclavable but should not be used for sterilization of surgical instruments.



18 x 9 x 3 cm
Blue

No. 20330-00



18 x 9 x 3 cm
Green

No. 20330-01



18 x 9 x 3 cm
Red

No. 20330-02



18 x 9 x 3 cm
Yellow

No. 20330-03

Instrument Case

This plastic case is compact, safe, secure, and slotted for placement of individual surgical instruments, aiding in the prevention of tip damage. Seven colors available. **Case is autoclavable but should not be used for sterilizing surgical instruments.**



Instruments not included.



17 x 8 x 2 cm
Blue

No. 20830-00



17 x 8 x 2 cm
Green

No. 20830-01

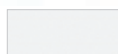

17 x 8 x 2 cm
Clear

No. 20830-02

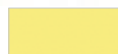

17 x 8 x 2 cm
Yellow

No. 20830-03



17 x 8 x 2 cm
Pink

No. 20830-04



17 x 8 x 2 cm
Orange

No. 20830-05



17 x 8 x 2 cm
Purple

No. 20830-06

INSTRUMENT CARE & ACCESSORIES

Roll Up Travel Case

Vinyl dissection roll up case with Velcro strap to hold the case closed. Holds up to 10 tools, one ruler holder, and one Velcro sealed pouch. **Instruments not included.**

Dimensions: 36 x 23 cm
 Color: Black
 Alloy / Material: Vinyl

No. 20831-10



Instrument Beaker with Silicone Bottom

Instruments are placed in the beaker with their tips immersed in distilled water when not in immediate use. This keeps the instruments clean and functional and ready to grasp. The instrument tips are protected from damage by the soft silicone rubber bottom. Segmented lid keeps instruments organized and secure.



Instrument not included.

Diameter: 10 cm
 Height: 8 cm

No. 00081-00

Instrument Holding Spring

For the safe placement of delicate surgical instruments during use. Pin the sharp ends into the drape to secure the mounting spring.

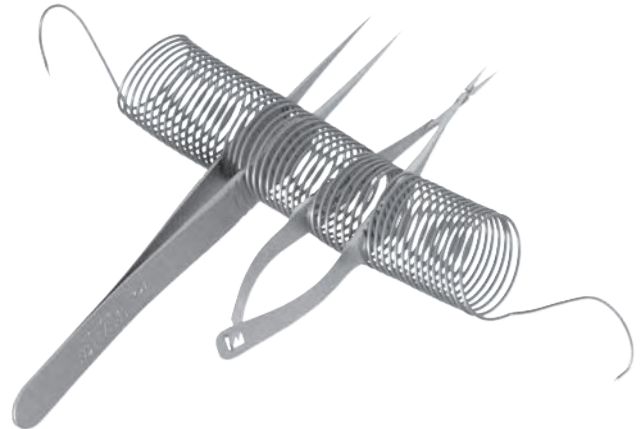

Instruments not included.

Length: 4 cm (closed)
 Diameter: 2 cm

No. 18090-00

Stainless Steel Burrs

Length: 44 mm
 Shaft diameter: 2.3 mm
 Pkg. of 10 burrs



Diameter (mm)	Item	Price
0.7*	No. 19008-07	
0.9**	No. 19008-09	
1.4	No. 19008-14	

* Use this size for screws No. 19010-10 (page 50).
 ** Use this size for screws No. 19010-00 (page 50).

Carbon Steel Burrs

Length: 44 mm
 Shaft diameter: 2.3 mm
 Pkg. of 10 burrs



Diameter (mm)	Item	Price
0.5	No. 19007-05	
0.7*	No. 19007-07	
0.9**	No. 19007-09	
1.4	No. 19007-14	
2.1	No. 19007-21	
2.9	No. 19007-29	

* Use this size for screws No. 19010-10 (page 50).
 ** Use this size for screws No. 19010-00 (page 50).

Tungsten Carbide Burrs

Length: 44 mm
 Shaft diameter: 2.3 mm
 Pkg. of 5 burrs



For more information see page 211.

Diameter (mm)	Item	Price
0.5	No. 19009-05	
0.7*	No. 19009-07	
0.9**	No. 19009-09	

* Use this size for screws No. 19010-10 (page 50).
 ** Use this size for screws No. 19010-00 (page 50).

Stainless Steel Trepines

Side opening for clearing of material.

Length: 44 mm
 Shaft diameter: 2.3 mm
 Sold individually



1.8 - 2.7 mm



5 mm

Outer Diameter (mm)	Item	Price
1.8	No. 18004-18	
2.3	No. 18004-23	
2.7	No. 18004-27	
5	No. 18004-50	

SURGICAL ACCESSORIES

Stainless Steel Circular Saw

For cutting bone and other hard substances.
 Attaches to mandrel (No. 18000-18), right.

Diameter: 16 mm
 Thickness: 0.1 mm



Pkg. of 10 saws
 No. 18000-20

Stainless Steel Mandrel

Screw allows attachment of discs and circular saws for use with high speed drills.

Length: 45 mm
 Shaft diameter: 2.3 mm

No. 18000-18



High Temperature Cautery Kit

This high temperature cauterizer is a great alternative to disposable cautery units. Temperature at tips is approximately 1000°C (1832°F). Replacement cautery tips are available.

Not autoclavable.



Plastic body
 Stainless steel tips: 0.2 mm diameter
 Operation temperature: 1000°C (1832°F)
 Total weight: 70 g
 Length: 16 cm (without tip)

Cautery kit includes:

- 1 Cautery handle
- 2 AA Batteries
- 2 Standard tips
- 1 Storage case
- 2 Fine tips

65% of actual size

Low Temperature Cautery Kit

This low temperature cautery kit is a great alternative to disposable cautery units. Temperature at the tips is approximately 649°C. Replacement cautery tips are available.

Not autoclavable.



Plastic body
 Stainless steel tips: 0.2 mm diameter
 Operation temperature: 649°C (1200°F)
 Total weight: 60 g
 Length: 12 cm (without tip)

Cautery kit includes:

- 1 Cautery Handle
- 2 AA Batteries
- 2 Fine Tips
- 1 Storage Case
- 2 Elongated Fine Tips

SURGICAL ACCESSORIES

MOST POPULAR



Replacement tips
 Straight standard
Sterile
Single use

Box of 10 tips
 No. 18010-01

MOST POPULAR



Replacement tips
 Straight fine
Sterile
Single use

Box of 10 tips
 No. 18010-02

MOST POPULAR

Cautery kit
 No. 18010-00



Replacement tips
 Elongated Straight Fine
Sterile
Single use

Box of 10 tips
 No. 18019-01



Replacement tips
 Straight Fine
Sterile
Single use

Box of 10 tips
 No. 18019-02

Cautery kit
 No. 18019-00

Small Vessel Cauterizer

This small hand-held unit keeps bleeding to a minimum and therefore provides a surgical field clear of clamps and hemostats. The cauterizer should be activated momentarily so the delicate tips do not burn out. Temperature at tips is approximately 1000°C (1832 °F). Replacement cautery tips are available. **Autoclavable.**



Heavy gauge stainless steel body
 Platinum-iridium tips: 0.3 mm diameter
 Total weight: 100 g
 Length: 13.5 cm (without tip)

Cautery kit includes:

- 1 Cautery handle
- 1 Straight fine tip
- 1 Angled fine tip
- 2 AA Batteries
- 1 Storage Case

Cautionary note:

Remove batteries before autoclaving.

80% of actual size

SURGICAL ACCESSORIES



Replacement tip
Straight fine

Cautery kit

No. 18000-00



Replacement tip
Angled fine

No. 18000-01



Replacement tip
Straight knife

No. 18000-03



Replacement tip
Straight knob

No. 18000-04

Neuro Punches

N.I.H. style neuro punches for punch removal of frozen brain microregions.



ID (mm)	OD (mm)	Gauge	Length (cm)	Item	Price
0.31	0.61	24	4.2	No. 18036-24	
0.41	0.70	22	4.5	No. 18036-22	
0.69	1.00	19	4.5	No. 18036-19	

Absorption Spears and Triangles

These synthetic surgical sponges absorb fluids twice as fast as the best cotton sponges and have three times their fluid-holding capacity. They are made from strong, soft, lint-free biocompatible-proven material that is non-irritating to delicate tissue and leaves no fibrous residue that might cause wound contamination. The Absorption Spears are sterilized by radiation.

MOST POPULAR



Absorption Spears
7 cm
Sterile

Box of 200 spears
No. 18105-01



Absorption Triangles
2 cm
Sterile

Box of 500 triangles
No. 18105-03

SURGICAL ACCESSORIES

Sample Corers

For quantitative analysis. Comes with plunger.

8.5 cm

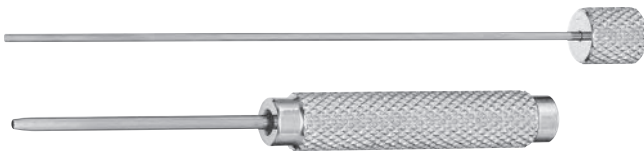

ID (mm)	OD (mm)	Gauge	Item	Price
0.35	0.80	21	No. 18035-35	
0.50	1.00	19	No. 18035-50	
0.80	1.45	17	No. 18035-80	
1.00	1.80	15	No. 18035-01	
2.00	3.00	11	No. 18035-02	
3.00	4.00	8	No. 18035-03	
5.00	6.00	4	No. 18035-05	

Fiber Optic Swabs



Straight

15 cm
Tip diameter: 2.5 mm
Pack of 100

No. 18106-01

Micro Cleaning Brush



70 mm
Nylon

Bag of 25

No. 18196-10

Miniature File Set

Comes with 8 different file profiles in a vinyl pouch.



10 cm
Carbon Steel

No. 30076-14

4-in-1 Screwdriver

With 4 hardened, interchangeable blades stored in handle: 1.5, 2, 2.5, and 3 mm.

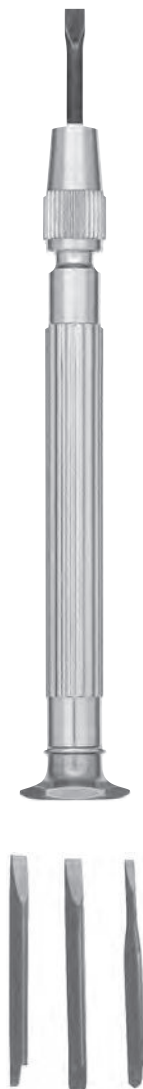

Handle 9.5 cm
With attachment 11.5 cm
Nickel handle

No. 30051-10

Ceramic Blade Cutter

Ceramic edge stays sharp 100 times longer than a steel edge. Rust and corrosion free. No trace metal contamination. **Autoclavable.**



Straight

13 cm
Cutting Edge: 58 mm
Ceramic blade
with plastic handle

No. 10025-70

Replacement Blade

Straight

Cutting Edge: 58 mm
Ceramic Blade

No. 10025-71

LABORATORY ACCESSORIES

UTILITY SCISSORS

Utility Scissors

These scissors are extremely hard (54 on the Rockwell scale). Useful for cutting tin or aluminum sheets, bone, plastics, etc. The strong, 3 mm thick blades are magnetic. The plastic handles are anatomically shaped.

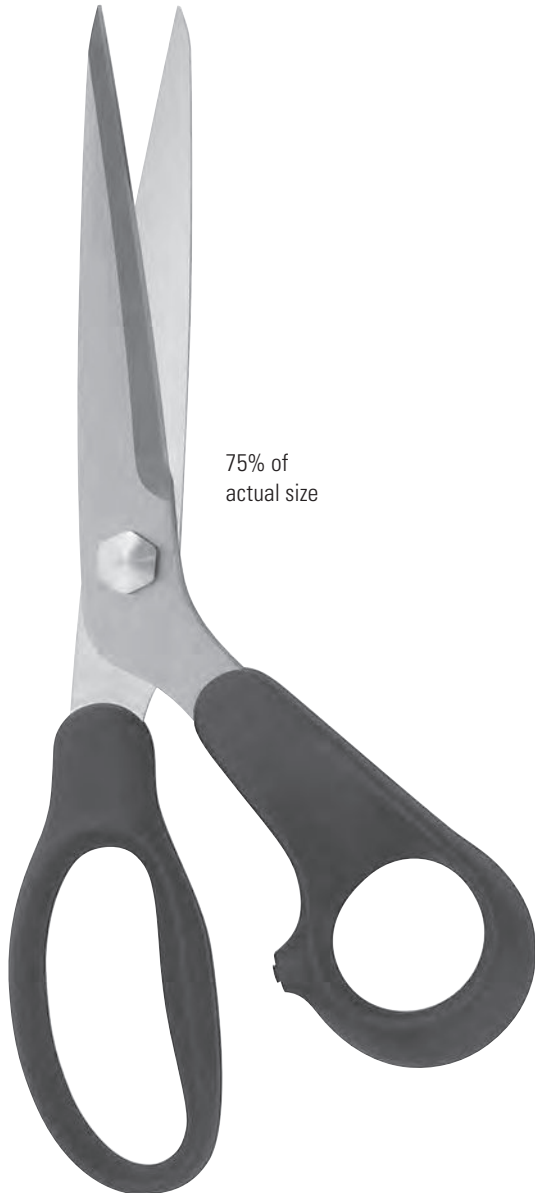

75% of
actual size

21 cm
Stainless steel
with plastic handle

No. 37500-00

Universal Scissors

The scissor blades are made of high quality stainless-steel and guarantee a perfect cut. Handles are made of glass fiber reinforced polyamide.



13 cm
Stainless steel
with plastic handle

No. 37500-05

Ruler with Gauge Measurements

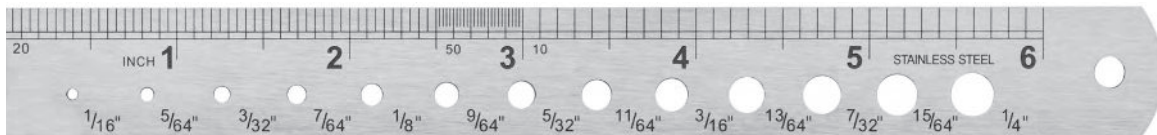

Front

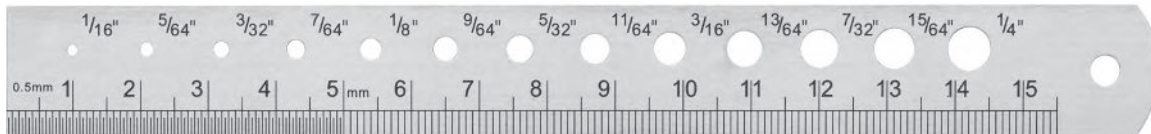

Back

90% of actual size

Stainless steel

15 cm (6")

No. 30085-15

Ruler with Metric Conversion Table



Front

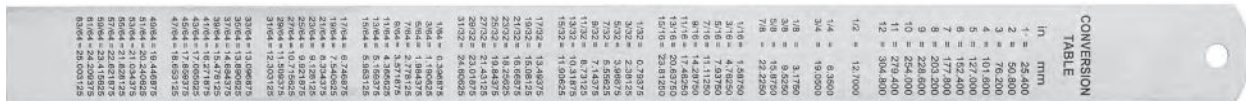

Back

50% of actual size

Stainless steel

30 cm (12")

No. 30085-30

Ruler Label

Used for stable measurements in all surgical platforms.

6 cm

Pkg. of 25 labels
No. 29027-00



CALIPERS

Plastic Vernier Caliper

Tough polymer is unbreakable under normal conditions. Measures inside, outside, step and depth, metric and inch to 0.1 mm or 1/64". Maximum measurement: 153 mm.

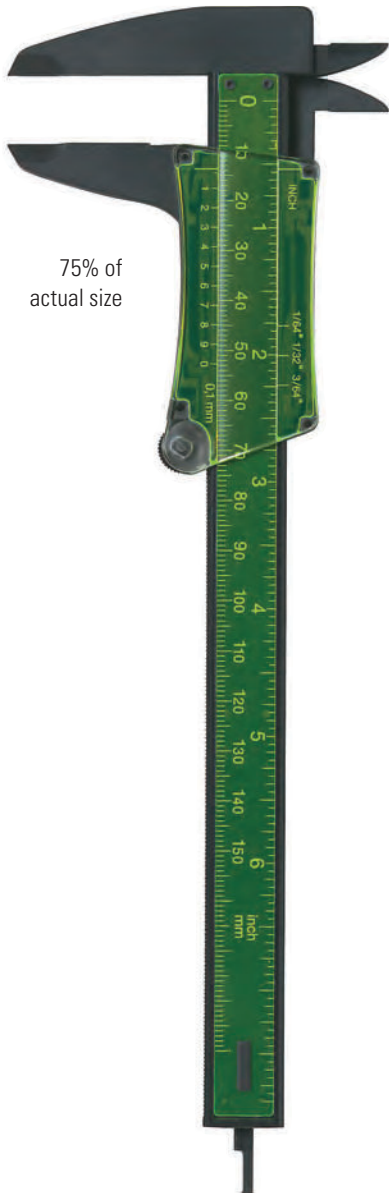

75% of actual size

Plastic

21 cm

No. 30087-20

Digital Electronic Caliper

Wide screen LED display with the ability to measure in millimeters, inches and fractions. Measures inside, outside, step and depth. Battery, spare battery and plastic storage case included.



70% of actual size

Stainless steel

23.5 cm

No. 30087-00

Castroviejo Surgical Caliper

Used for precise measurement during surgery.



0-20 mm with 0.5 mm divisions
Tip diameter: 0.5 mm

8.5 cm

No. 18000-35

Magnifying Loupe with Micrometer and LED

High quality loupe features a removable micrometer and ultra-bright LED lights surrounding the circumference for a defined image and clear contrast.

Magnification: 10x
Field of view: 30 mm
Working distance: 10 mm
(without scale)
Illumination: Ultra-bright LED
38 x 38 x 40 mm

No. 29026-10



Stage Micrometers

These are highly accurate stage micrometers for use with transmitted light in both compound and stereo microscopes. Comes with a plastic case.

76 x 26 mm

10 mm with 100 divisions (0.1 mm)
No. 29025-01

1 mm with 100 divisions (0.01 mm)
No. 29025-02



Electronic Clock / Triple Timer

Three activities can be timed up or down simultaneously or individually. Time can be displayed either in 12 or 24 hours and features a memory function. Maximum countdown time is 19 hours, 59 minutes, 59 seconds. Minimum time interval is 1 second. The timer housing includes a powerful magnet for mounting.

LCD display: 4.5 x 4.5 cm
 7 x 8.5 x 1.5 cm
 AAA battery included

No. 27000-01



Gold Wire Contacts

Matching pin and socket. Contacts are crimp terminated, but also can be used for solder connections.

Total length: 16 mm (when connected together)
 Diameter: 1.2 mm
 Opening for wire: 0.63 mm

Pkg. of 50 male contacts
 No. 19003-00

Pkg. of 50 female contacts
 No. 19003-01

Enlarged 225%

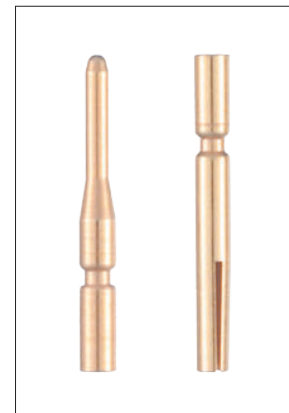

Headband Magnifier

Precision ground and polished optical glass lenses. The padded headband is lightweight and fully adjustable. Can be worn with spectacles.



Headband magnifier shown with VisorLIGHT™ (sold separately).

Magnification: 2.5x
Working distance: 200 mm (8")

No. 28030-02

Magnification: 2.75x
Working distance: 150 mm (6")

No. 28030-03

Magnification: 3.5x
Working distance: 100 mm (4")

No. 28030-04

VisorLIGHT™

Small, portable light source with 26 cm cord for attachment to headband. It comes with a battery pack that holds two AA batteries. Completely adjustable. Replacement bulbs are available upon request.



No. 28030-10

Interchangeable Magnifier Headset with LED

Economical and fully interchangeable headband magnifier with LED light.

Includes:

- Multiple Lens Magnifications (1.0x, 1.5x, 2.0x, 2.5x, 3.5x)
- LED Light Source
- Tilting Functionality
- Cushioned Nose Pads
- Adjustable Headband
- Interchangeable Lens Frames
- Requires 3 AAA Batteries (Batteries not included)

MOST POPULAR



Can be used with or without the adjustable head strap (included).



Magnification: 1x, 1.5x, 2x, 2.5x, and 3.5x
Field of view: Variable
Working distance: Variable

No. 28080-10

Galilean Loupes

These loupes are lightweight and easy to use. Made from the finest optical coated lenses which deliver excellent clarity and high resolution. The loupes are mounted onto a strong yet flexible wraparound safety frame with a headband for stability and comfort. Ability to flip loupes up for use as safety glasses. Comes with mini screwdriver for fine adjustments, micro cloth, and storage case.



Magnification: 3x
Working distance: 400 mm (16")
Weight: 72 g

No. 28050-30

Magnification: 3.5x
Working distance: 300 mm (12")
Weight: 77 g

No. 28050-35

Eschenbach Magnifier Spectacles

These magnifier spectacles allow full adjustments on almost all parts. Headband keeps spectacles steady and in place. Leather case and Headband included.



Magnification: 2.5x
Working distance: 350 mm (14")
Weight: 70 g
Plastic frame reinforced
with fiberglass

No. 28040-30

Spectacles Headband

Compatible with the Eschenbach Max Detail Spectacles (Item No. 28030-20) and Eschenbach Magnifier Spectacles (Item No. 28040-30).



Material: Neoprene

No. 28080-90

Eschenbach Max Detail Spectacles

These spectacles are portable, lightweight, and easily adjustable. Designed with frosted objective lens housing which eliminates distracting reflections. Bendable ear pieces for a secure, comfortable fit. Protective case is included.



Max Detail Spectacles shown with Eschenbach Clip-On LED Light (sold separately).

Magnification: 2x
 Field of view: 110 mm (4")
 Working distance: 400 mm (16")
 Weight: 49 g

No. 28030-20

Eschenbach Clip-On LED Light

A compact and lightweight light source with two high-performance SMD LED's and a lens that concentrates the light producing a more powerful, bright and homogenous field of view. Light can be set high or low. Compatible with the Max Detail Spectacles and Headband Magnifiers. Comes with 3 AA batteries and storage case.



Gross Weight: 106 g (including batteries)

No. 28030-25

Eschenbach Vario Flex with LED

The Vario LED Flex ensures ease and precision by its smooth flexible neck and tiltable magnifying lens. This magnifier's innovative features provide a spacious working platform suitable for any application. Mounting clamp provides uncompromised workspace due to its sturdy, slim design. The magnification lens is illuminated with shadow-free full or half ring optimum bright LEDs.

Magnification: 2.5x
 Diopter: 6D
 Lens size: 76 mm
 Lens shape: Aspheric
 Working distance: Variable
 Lens material: PXM® lightweight lens with patented Ceratec® scratch-resistant coating
 Illumination: Latest SMD LED technology
 Power source: 120V & 220V

No. 28015-25



Eschenbach Scribolux Magnifier

This magnifier provides an illuminated platform suitable for any working condition. The open design allows for a spacious working platform. Supplied in a microfiber pouch for protecting and cleaning the lens.

Magnification: 2.8x
 Diopter: 7/11D
 Lens size: 100 x 75 mm
 Lens shape: Aspheric
 Working distance: 75 mm (3")
 Lens material: PXM® lightweight lens with patented Ceratec® scratch-resistant coating
 Illumination: Latest SMD LED technology
 Power source: 4 AA batteries (included)

No. 28020-28



Optical Cleaning Kit

This convenient kit contains everything you need to clean lens surfaces safely. Perfect for microscopes, camera lenses, binoculars, telescopes, graphic art optics, and all other fragile lenses. Storage case included.

Kit includes:

- 1 Bottle of lens cleaner (30 ml)
- 1 Ultra soft duster brush
- 1 Cleaning cloth (20 x 20 cm)
- 3 Books of lens paper (25 sheets each)



No. 29000-10

Lens Paper

This premium grade optical lens tissue is extremely soft and safe for any glass or plastic optical lens surface.



15 x 10 cm

Book of 50 sheets
No. 29015-50

Eschenbach mobilux® DIGITAL inspection

The reflection-free and high-contrast 4.3-inch display ensures relaxed work. The HD camera arranged centrally under the display enables easy orientation. A magnification of up to 15x can be selected continuously or in increments by touching the magnifying glass symbol. The integrated LED lighting offers great variability in lighting and exposure settings for a wide variety of applications. The mobilux® offers measurement and comparison functions via adjustable scales and templates as well as simultaneous comparison measurements of the target and actual status via a split screen on the PC.

With the photo function, the live image seen through the magnifying glass can be saved as a photo on an inserted SD card. The images can also be easily transferred to a computer via a USB connection. In addition, the USB connection to the computer enables the live image of the magnifying glass to be transferred to the PC monitor, so the mobilux® can also be used as a screen reader. The "mobilux® digital" program supplied must first be installed on the computer (Windows Vista, Windows 7, 8 or Windows 10).



Delivery incl. USB cable length 2m, SD memory card (incl. software), hand strap, manual, case for storage, calibration plate. Mains adapter for EU, GB, US, AUS included.

- Magnification: 4-15x
- Field of view: Variable
- Working distance: Variable
- Screen size: 11 cm (4.3")
- Screen resolution: 480 x 272 px
- User input: Touchscreen

No. 28070-50

Eschenbach laboCOMFORT

With the laboCOMFORT, both hands remain free to work. The screen can be folded up when not in use. Various locking options for individual height adjustment of the magnifying screen. The headband magnifier can also be used by people who wear glasses.



Can be used with the Eschenbach Clip-On LED light.

- Magnification: 3x
- Working distance: 130 mm (5")

No. 28030-13

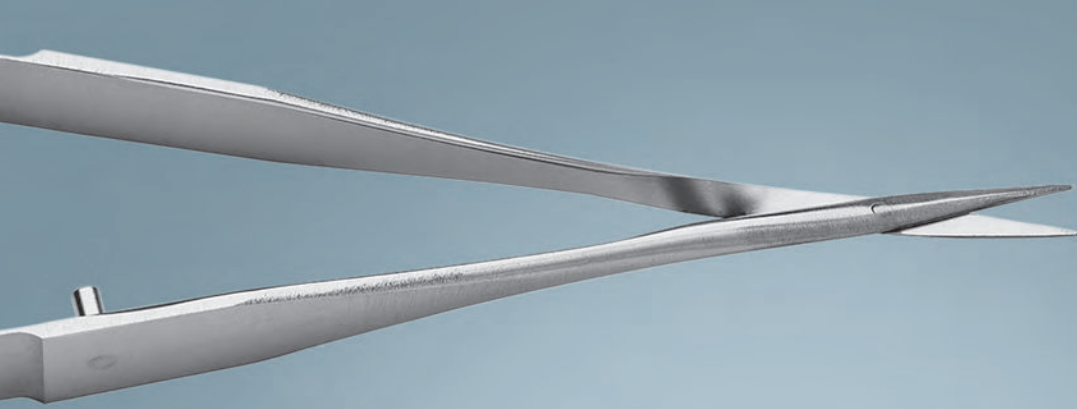

Student Instruments

Scissors	Pages	186 – 191
Cutter	Page	191
Scalpel Handles	Page	192
Forceps	Pages	193 – 198
Hemostat, Artery Clamps, Pin & Needle Holders, Retractor, Vessel Dilator & Clamp	Pages	199 – 207





FST Student Quality Instruments

One of the hallmarks of FST has always been to accurately assess the needs of our customers. We gather information not only from the lab, but from conferences, journals and researchers. Whether it is designing new tools or finding new applications for existing instruments, we believe our best information comes directly from you.

Our customers wanted reduced costs and quantity discounts without sacrificing the precision and quality inherent in German instruments. To meet their needs, we have developed a full line of “student” instruments. They were created for use in the classroom where students are learning proper instrument care.

Unlike our competitors, the quality of these instruments does not drop dramatically with the price. Our student line uses quality stainless steel and maintains the precision you expect from FST. In addition they carry our unconditional satisfaction guarantee while being offered at a significantly reduced price.

Not intended as a substitute for our highest quality instruments, the student line may require extra care as the alloys used are more susceptible to corrosion. All of our shipments come with an instruction pamphlet describing the use and care of surgical instruments. Visit our website at finescience.com for more information.

Features:

- Economy
- Quantity discounts
- Quality
- Less hand finishing
- Less expensive alloys

Vannas Spring Scissors

Ideal for introductory courses in microdissection. The manufacturer, material and general pattern are the same as our No. 15003-08 but with much of the costly hand finishing omitted.

MOST POPULAR
91500-09



% DISCOUNT

Quantity discount for student instruments:

5-9 = 5%
10+ = 10%

Per item, selection cannot be assorted for discount.

STUDENT



Straight Sharp/Sharp

9 cm
Cutting edge: 5 mm
Tip Ø: 0.35 mm

No. 91500-09



Curved Sharp/Sharp

9 cm
Cutting edge: 5 mm
Tip Ø: 0.35 mm

No. 91501-09

Fine Scissors

MOST POPULAR
91460-11



Straight Sharp/Sharp

11,5 cm
Cutting edge: 20 mm

No. 91460-11



Curved Sharp/Sharp

11,5 cm
Cutting edge: 20 mm

No. 91461-11

Straight Sharp/Sharp

12 cm
Cutting edge: 20 mm

No. 91460-12

Curved Sharp/Sharp

12 cm
Cutting edge: 20 mm

No. 91461-12

Sanvenero



Straight Sharp/Sharp

14.5 cm
Cutting edge: 30 mm

No. 91408-14

Surgical Scissors



Length (cm)	Cutting edge (mm)	Straight Sharp/Sharp	Price	Straight Sharp/Blunt	Price	Straight Blunt/Blunt	Price
10.5	35	No. 91402-10		No. 91401-10		No. 91400-10	
12	40	No. 91402-12		No. 91401-12		No. 91400-12	
13	40	No. 91402-13		No. 91401-13			
14.5	45	No. 91402-14		No. 91401-14		No. 91400-14	



Length (cm)	Cutting edge (mm)	Curved Sharp/Sharp	Price	Curved Sharp/Blunt	Price
11.5	40	No. 91405-11			
12	40			No. 91404-12	
13	40	No. 91405-13		No. 91404-13	
14.5	45	No. 91405-14		No. 91404-14	

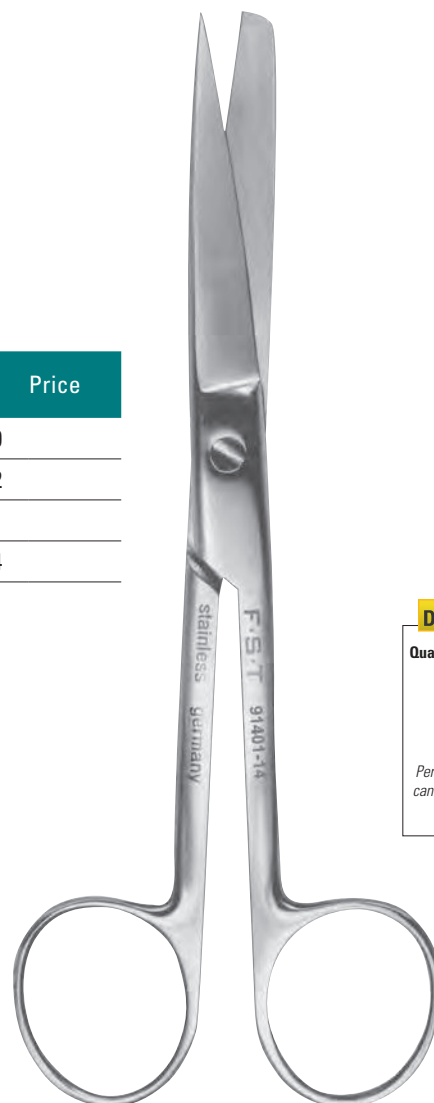

**%
DISCOUNT**

Quantity discount
for student
instruments:

5-9 = 5 %
10+ = 10 %

*Per item, selection
cannot be assorted
for discount.*

STUDENT

Wagner

Spencer Ligature



**%
DISCOUNT**

**Quantity discount
for student
instruments:**

5-9 = 5%
10+ = 10%

*Per item, selection
cannot be assorted
for discount.*



Straight
Sharp / Sharp

11.5 cm
Cutting edge: 25 mm

No. 91468-12



Straight
Sharp / Sharp

9 cm
Cutting edge: 20 mm

No. 91476-09

STUDENT

Lister Scissors

Longer blunt blade prevents damaging tissue underneath skin without losing the cutting line.



Mayo

90% of actual size



**%
DISCOUNT**

Quantity discount for student instruments:

5-9 = 5%
10+ = 10%

Per item, selection cannot be assorted for discount.

STUDENT



Angled to side
Blunt/Blunt

14 cm
Cutting edge: 35 mm

No. 91413-14



Angled to side
Blunt/Blunt

18 cm
Cutting edge: 45 mm

No. 91413-18



Angled to side
Blunt/Blunt

20 cm
Cutting edge: 50 mm

No. 91413-20



Curved
Sharp/Blunt

14.5 cm
Cutting edge: 50 mm

No. 91409-15



Straight
Blunt/Blunt

17 cm
Cutting edge: 50 mm

No. 91410-17



Curved
Blunt/Blunt

17 cm
Cutting edge: 50 mm

No. 91411-17

Metzenbaum Baby

Metzenbaum



**%
DISCOUNT**

**Quantity discount
for student
instruments:**

5-9 = 5%
10+ = 10%

*Per item, selection
cannot be assorted
for discount.*

STUDENT



Curved
Blunt/Blunt

14.5 cm
Cutting edge: 30 mm

No. 91419-14



Straight
Blunt/Blunt

14.5 cm
Cutting edge: 35 mm

No. 91416-14



Curved
Blunt/Blunt

18 cm
Cutting edge: 35 mm

No. 91417-18

Heavy Scissors



Curved
Heavy Blades
Sharp/Sharp
10.5 cm
Cutting edge: 30 mm
No. 91405-10



Bone Scissors

For cutting fine bone.



Curved
9 cm
Cutting edge: 9 mm
No. 91604-09



Bone Cutter

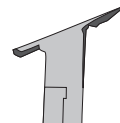

Angled 30°
11 cm
Cutting edge: 19.5 mm
Blue Plastic Handle
No. 91601-11



**%
DISCOUNT**

Quantity discount
for student
instruments:

5-9 = 5%
10+ = 10%

*Per item, selection
cannot be assorted
for discount.*

STUDENT

Scalpel Handle #4

Standard Scalpel Handle #3



**%
DISCOUNT**

**Quantity discount
for student
instruments:**

5-9 = 5%
10+ = 10%

*Per item, selection
cannot be assorted
for discount.*

For scalpel blades,
see page 59.

For scalpel blades,
see page 60.

#4
13 cm
No. 91004-13

#3
12 cm
No. 91003-12

STUDENT

Dumont #5

MOST
POPULAR



Standard tip
Straight

11 cm
Inox
0.1 x 0.06 mm

No. 91150-20

Dumont #7

MOST
POPULAR



Standard tip
Curved

11 cm
Inox
0.17 x 0.1 mm

No. 91197-00

**%
DISCOUNT**

Quantity discount
for student
instruments:

5-9 = 5%
10+ = 10%

*Per item, selection
cannot be assorted
for discount.*

STUDENT

Fine Forceps Straight



Fine Forceps Broad Shanks



Fine Forceps Curved



Fine Forceps Angled



**%
DISCOUNT**
Quantity discount
for student
instruments:
5-9 = 5%
10+ = 10%
*Per item, selection
cannot be assorted
for discount.*

STUDENT



Straight

11 cm
0.2 x 0.1 mm

No. 91115-10



Broad Shanks

12 cm
0.2 x 0.2 mm

No. 91113-10



Curved

12 cm
0.2 x 0.2 mm

No. 91117-10



Angled

11 cm
0.2 x 0.2 mm

No. 91110-10

Feilchenfeld



Straight

9.5 cm
Tip Ø: 0.75 mm

No. 91139-09



Straight

11.5 cm
Tip Ø: 1 mm

No. 91139-12

Splinter Forceps



Straight
Sharp

10.5 cm
Tip Ø: 0.3 mm

No. 91156-11

**%
DISCOUNT**

**Quantity discount
for student
instruments:**

5-9 = 5 %
10+ = 10 %

*Per item, selection
cannot be assorted
for discount.*

STUDENT

Micro Adson



80% of actual size



Serrated
12 cm
Tip width: 0.7 mm
No. 91118-12

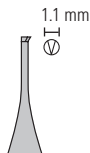

1x2 teeth
12 cm
Tip width: 1.1 mm
No. 91119-12

Adson

Wide, strong grip with narrow tips.



80% of actual size



Serrated
12 cm
Tip width: 1.5 mm
No. 91106-12

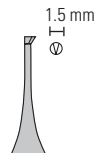

1x2 teeth
12 cm
Tip width: 1.5 mm
No. 91127-12

Adson-Brown



F. S. T. 91162-12
Germany, Solingen

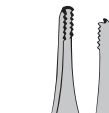

Shark teeth
12 cm
Tip width: 2.5 mm
No. 91162-12

Adson with Cross Serrations



F. S. T. 91427-12
Germany, Solingen

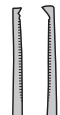

1x2 teeth
Cross-serrations
12 cm
Tip width: 1.3 mm
No. 91427-12

**%
DISCOUNT**

Quantity discount for student instruments:

5-9 = 5%
10+ = 10%

Per item, selection cannot be assorted for discount.

STUDENT

Standard Pattern

Broad pattern with strong spring action.

MOST POPULAR
91100-12

Anatomical Standard Pattern



Straight Serrated

Tip width (mm)	Length (cm)	Item	Price
2.5	11.5	No. 91100-12	
2.7	13	No. 91100-13	
3	14.5	No. 91100-14	
3.5	16	No. 91100-16	
4	17	No. 91100-17	

Surgical Standard Pattern

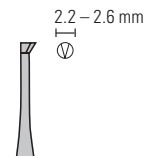

Straight 1x2 teeth

Tip width (mm)	Length (cm)	Item	Price
2.2	12	No. 91121-12	
2.4	13	No. 91121-13	
2.6	14.5	No. 91121-14	
2.8	15.5	No. 91121-15	
3	16	No. 91121-16	
3.5	18	No. 91121-18	
4	20	No. 91121-20	
4.5	25	No. 91121-25	



% DISCOUNT

Quantity discount for student instruments:

5-9 = 5%
10+ = 10%

Per item, selection cannot be assorted for discount.

Anatomical Narrow Pattern



Straight Serrated

Tip width (mm)	Length (cm)	Item	Price
1.5	11.5	No. 91102-12	
2.1	13	No. 91102-13	
2.2	14.5	No. 91102-14	
2.3	16	No. 91102-16	

Surgical Narrow Pattern

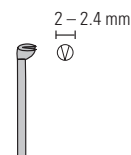

Straight 1x2 teeth

Tip width (mm)	Length (cm)	Item	Price
2	11.5	No. 91123-12	
2.2	14.5	No. 91123-14	
2.4	16	No. 91123-16	

STUDENT

Semken



Straight
11.5 cm
Tip width: 1.2 mm
No. 91108-12

Straight
14.5 cm
Tip width: 2.2 mm
No. 91108-14

Gillies



80% of actual size

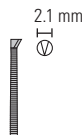

1x2 teeth
Cross-Serrated
15.5 cm
Tip width: 2.1 mm
No. 91128-15

Russian

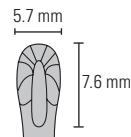

15 cm
Tip dimensions: 7.6 x 5.7 mm
No. 91126-15

McIndoe



Serrated
15 cm
Tip width: 1.2 mm
No. 91138-15

**%
DISCOUNT**

Quantity discount for student instruments:

5-9 = 5%
10+ = 10%

Per item, selection cannot be assorted for discount.

STUDENT

Halsted-Mosquito

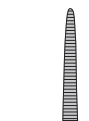

Straight
Serrated

12.5 cm
Tip width: 1.4 mm

No. 91308-12



Curved
Serrated

12.5 cm
Tip width: 1.4 mm

No. 91309-12



Curved
1x2 teeth and
Serrated

12 cm
Tip width: 1.9 mm

No. 91331-12

Hartmann



Curved
Serrated

10 cm
Tip width: 1.6 mm

No. 91303-10

**%
DISCOUNT**

**Quantity discount
for student
instruments:**

5-9 = 5%
10+ = 10%

*Per item, selection
cannot be assorted
for discount.*

STUDENT

Crile

Kelly



80% of actual size



**%
DISCOUNT**

Quantity discount for student instruments:

5-9 = 5%
10+ = 10%

Per item, selection cannot be assorted for discount.



Straight
Serrated

14 cm
Tip width: 1.3 mm

No. 91304-14

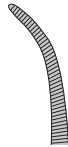

Curved
Serrated

14 cm
Tip width: 1.3 mm

No. 91305-14



Straight
Serrated

14.5 cm
Tip width: 1.6 mm

No. 91318-14



Curved
Serrated

14.5 cm
Tip width: 1.8 mm

No. 91319-14

STUDENT

Rochester-Pean

Pean



80% of actual size



Straight Serrated

14 cm
Tip width: 2 mm

No. 91316-14



Curved Serrated

14 cm
Tip width: 2 mm

No. 91317-14

Straight Serrated

16 cm
Tip width: 2.5 mm

No. 91316-16

Curved Serrated

16 cm
Tip width: 2.5 mm

No. 91317-16



Straight Serrated Narrow

14 cm
Tip width: 2 mm

No. 91322-14



Curved Serrated Narrow

14 cm
Tip width: 2 mm

No. 91323-14

**%
DISCOUNT**

Quantity discount for student instruments:

5-9 = 5%
10+ = 10%

Per item, selection cannot be assorted for discount.

STUDENT

Ochsner-Kocher

Kocher

80% of actual size

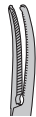

Straight
Serrated
1x2 teeth

14 cm
Tip width: 2.2 mm

No. 91328-14

Curved
Serrated
1x2 teeth

14 cm
Tip width: 2.2 mm

No. 91329-14

Straight
Serrated
1x2 teeth

16 cm
Tip width: 3 mm

No. 91328-16

Curved
Serrated
1x2 teeth

16 cm
Tip width: 3 mm

No. 91329-16



Straight
Serrated
Narrow 1x2 teeth

14 cm
Tip width: 2.2 mm

No. 91330-14

Curved
Serrated
Narrow 1x2 teeth

14 cm
Tip width: 2.2 mm

No. 91331-14

**%
DISCOUNT**

Quantity discount for student instruments:

5-9 = 5%
10+ = 10%

Per item, selection cannot be assorted for discount.

STUDENT

Backhaus Towel Clamp

Tohoku Towel Clamp



**%
DISCOUNT**

**Quantity discount
for student
instruments:**

5-9 = 5%
10+ = 10%

*Per item, selection
cannot be assorted
for discount.*



9 cm

No. 91195-09



11 cm

No. 91195-11



13 cm

No. 91195-13



Serrated

10 cm

Tip width: 2.4 mm

No. 91194-10



Serrated

13 cm

Tip width: 2.8 mm

No. 91194-13

STUDENT

Lorna Towel Clamp

Babcock



**%
DISCOUNT**

**Quantity discount
for student
instruments:**

5-9 = 5%
10+ = 10%

*Per item, selection
cannot be assorted
for discount.*

STUDENT



Serrated

13 cm
Tip width: 7 mm

No. 91196-13



Serrated

16 cm
Tip width: 6 mm

No. 91393-16

Allis Clamp

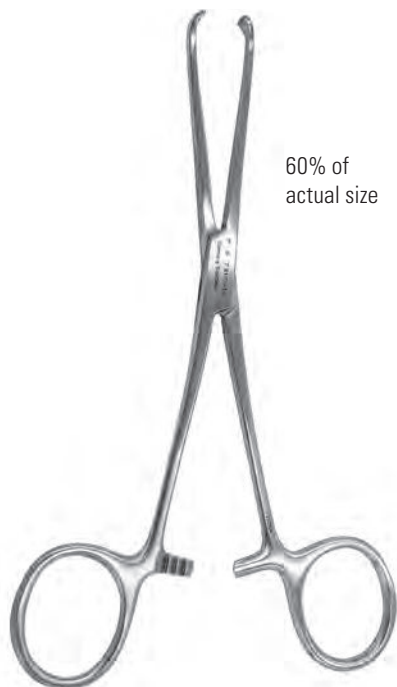

60% of actual size

5x6 Teeth
15 cm
Tip Width: 6 mm
No. 91191-15

Hose Clamp



60% of actual size

Cross-Serrated
15 cm
Tip Width: 4 mm
No. 91198-15

Lister Sine Clamp



60% of actual size

Serrated
16 cm
Tip Width: 3 mm
No. 91199-16



Quantity discount for student instruments:

5-9 = 5%
10+ = 10%

Per item, selection cannot be assorted for discount.

STUDENT

Pin Holder



Halsey

MOST POPULAR



80% of actual size

Mayo-Hegar



80% of actual size

% DISCOUNT

Quantity discount for student instruments:

5-9 = 5%
10+ = 10%

Per item, selection cannot be assorted for discount.

For pins, see page 115.

For suture needles, see page 122 & 123.

For suture needles, see page 122 & 123.

STUDENT



Straight

13 cm
Tip width: 1.5 mm

clamping length: 18 mm
with lock
without scissors

No. 91201-13



Straight

16 cm
Tip width: 2.6 mm

clamping length: 21 mm
with lock
without scissors

No. 91204-16

Nickel-plated

7.5 cm

Jaw opening: 0-1 mm

No. 91606-07

Senn-Miller



16 cm
3 sharp teeth 7 x 8 mm
1 blunt tooth 18 x 6 mm
No. 91790-16

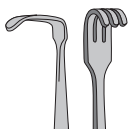

16 cm
3 blunt teeth 7 x 8 mm
1 blunt tooth 18 x 6 mm
No. 91791-16

Vessel Dilator

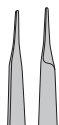

Angled 10°
11 cm
Tip diameter: 0.3 mm
No. 91815-11

Spring-Loaded Retractor

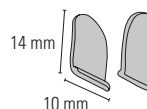

Curved atraumatic blades
8.5 cm
Maximum spread: 3 cm
Blade dimensions: 14 x 10 mm
No. 91706-05

Barraquer



3 cm
Maximum spread: 1.1 cm
Tip dimensions: 5 x 7 mm
No. 91700-03

Dieffenbach



Straight
35 mm
Strong pressure
No. 91850-35

**%
DISCOUNT**

Quantity discount
for student
instruments:

5-9 = 5 %
10+ = 10 %

*Per item, selection
cannot be assorted
for discount.*

STUDENT



Reference Pages

Worldwide Locations	Page	209
Scissors Test	Page	210
Features and Alloys	Page	211
Maintenance and Care	Pages	212 – 214
Quality Control	Page	215
Selection	Page	216
Dumont	Page	217
Numerical Index	Pages	218 – 221
Alphabetical Index	Pages	222 – 227
Additional Information	Page	228

Fine Science Tools Around the World

Commitment to excellence

For decades, we've demonstrated our commitment to excellence with genuine quality and a 100% satisfaction guarantee. As a result, our products continue to be the preferred instruments among scientists and biomedical researchers worldwide.

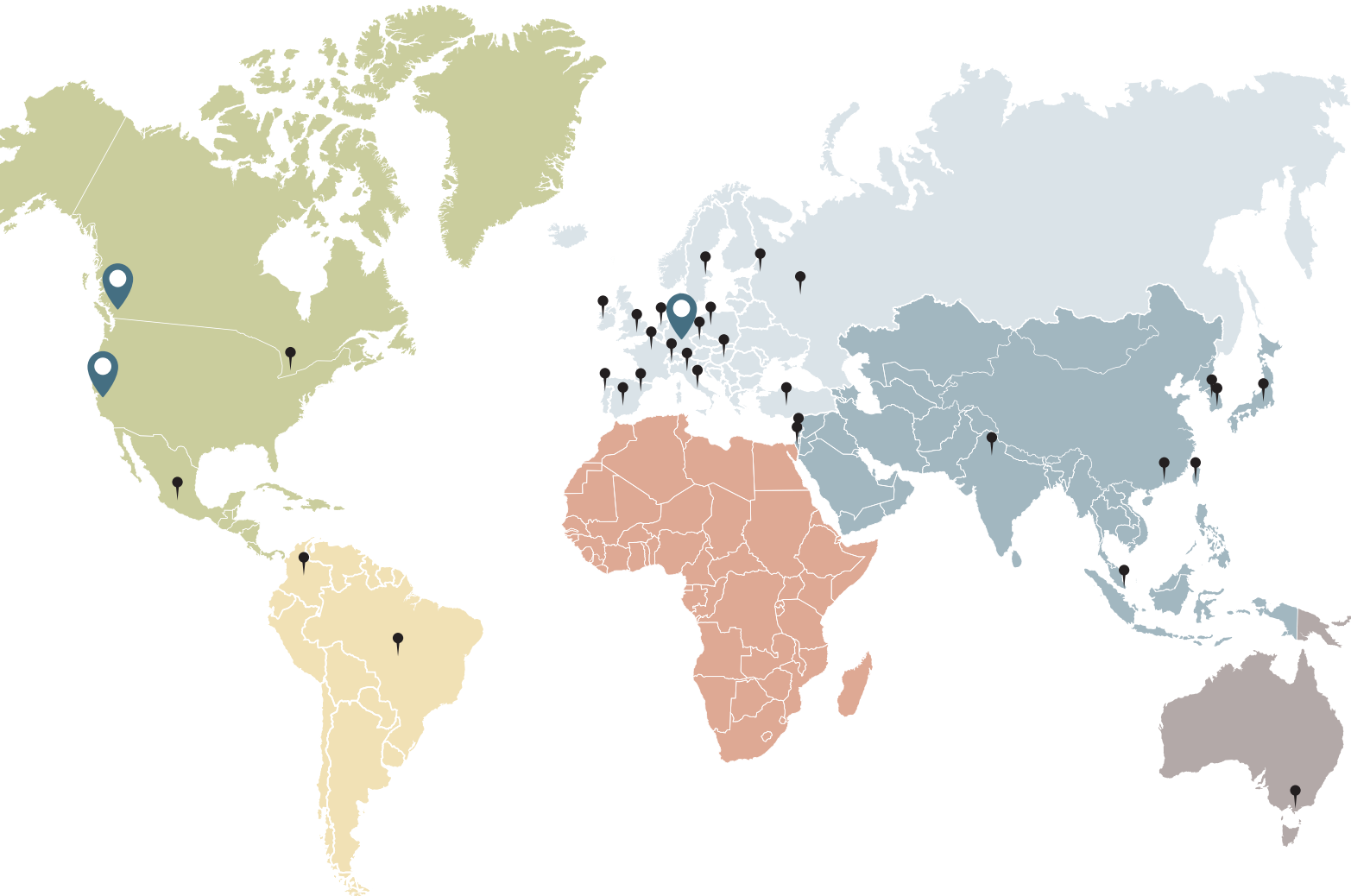

We have offices and dealers throughout the world and have been shipping globally since 1974.



Offices

finescience.com
finescience.de
finescience.ca

USA
Europe
Canada



Dealers

To see a complete list of Fine Science Tools dealers, please visit us at finescience.com/dealers

WORLDWIDE

Does paying more for a pair of scissors really buy more value and a longer cutting life?

Pictured below is a scissors testing device used to compare various alloys and cutting edge styles. The scissors repeatedly cut through a continuous feed of cotton cloth, and a counter keeps track of the number of cuts made to evaluate when the scissors begin to show a decrease in cutting quality.

The results verify that the addition of various features dramatically increases the cutting life of the scissors. Most notably, the cutting life is more than doubled with the addition of ToughCut blades to stainless steel, and over six times longer with CeramaCut blades.

See the chart below for a comparison of four different scissors sold by FST.



The cutting life is more than doubled with the addition of ToughCut blades to stainless steel, and over six times longer with CeramaCut blades.

Alloy/Material	Lasts longer than stainless steel by:
Tungsten Carbide	1.9x
Stainless Steel with ToughCut	2.3x
Tungsten Carbide with ToughCut	4.1x
CeramaCut (Ceramic Coated Tungsten Carbide with ToughCut)	6.6x

See page 211 for more information on ToughCut, Tungsten Carbide and CeramaCut.



Tungsten Carbide Instruments

Golden handles (short gold plating)

Last approx. 1.9x longer than stainless steel

Is welded onto the cutting edges of scissors or tips of forceps and needles holders

Available instruments: bone cutters, scissors, forceps, needles, needle holders, burrs

Look for this symbol

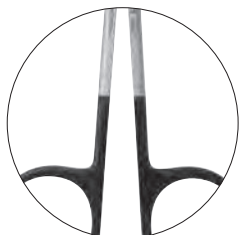

ToughCut® Scissors

Black handles

Last approx. 2.3x longer than stainless steel

One cutting edge has micro serrations to minimize tissue slippage

One cutting edge has increased sharpness (cutting edge with a 30° instead of 15° angle)

Look for this symbol



ToughCut is a registered trademark of Fine Science Tools (USA) Inc.

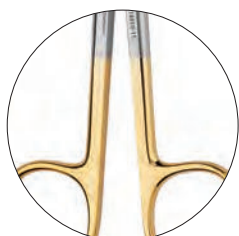

Tungsten Carbide & ToughCut® Scissors

Golden handles (long gold plating)

Last approx. 4.1x longer than stainless steel

One cutting edge has micro serrations to minimize tissue slippage

One cutting edge has increased sharpness (cutting edge with a 30° instead of 15° angle)

Look for this symbol



CeramaCut® Scissors

Golden handles and black coating

Last approx. 6.6x longer than stainless steel

Cutting edges with Tungsten Carbide and Tough Cut plus ceramic coating

Ceramic is one of the hardest materials on earth

Reduced glare

Look for this symbol



CeramaCut is a registered trademark of Fine Science Tools (USA) Inc.



Ceramic Instruments

Ceramic coating

Last approx. 2.3x longer than stainless steel

Ceramic is one of the hardest materials on earth

Reduced glare

Available instruments: Dumont forceps and spring scissors

Look for this symbol

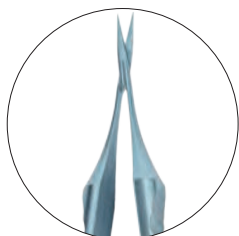

Titanium Instruments

Approx. 40% lighter than stainless steel

Softer alloy than stainless steel

Corrosion resistance (cannot rust)

Non-Magnetic

High temperature resistance up to 440°C / 824°F

Available instruments: scissors, forceps, probes, hooks, spatula, vascular clamps

Look for this symbol



Maintenance and Care

Proper care of your surgical instruments will improve their longevity and function. Below are different cleaning, sterilization, and maintenance processes to guide you through your techniques.

General





Guidelines to extend the life of your surgical instruments.

- Clean and thoroughly dry your instruments as soon as possible after each use, paying special attention to joints, hinges, and anywhere there is metal to metal contact.
- Handle your instruments delicately and with care.
- Use your instruments for their intended purpose.
- Store your instruments with tip protectors, and always place them so that they do not touch each other.





Cleaning

Fine surgical instruments should be cleaned immediately after use. Blood or saline solutions left on instruments for any length of time can quickly start corrosive action. Time, temperature, and agitation play important roles in the cleaning process. Time affects the efficiency of cleaning solutions as most are effective after a certain time period. Higher temperature cleaning solutions result in better cleaning. During manual or ultrasonic cleaning it is helpful to loosen any surgical residue. Before any of the below procedures, rinse your instruments under warm running water to remove all blood and tissue. Instruments can be cleaned manually or ultrasonically, but always:

-  Use a neutral pH (pH 7) cleaning solution.
-  Clean instruments in the open position to ensure a thorough and effective cleaning process.
-  Use soft textile or paper cloths, soft plastic brushes made of nylon, or water spray guns.
-  Do NOT use steel wool, wire brushes, or scouring pads as these are abrasive to the instruments.



Manual Cleaning

-  Make sure all instruments are visibly clean and free from stains, wiping them carefully to remove all blood and tissue matter.
-  Rinse instruments thoroughly with distilled water, paying close attention to joints and hinges as these areas can accumulate unwanted material.
-  Air dry your instruments completely and use a can of compressed air to blow out any water at the joints and hinges. Then store them only in clean and dry environments.



Ultrasonic Cleaning

Ultrasonic cleaning is the most effective cleaning method. The vibrating sound waves create micron-sized bubbles in the solution that grow with the alternating pressure. When the bubbles reach a particular size, they collapse creating a force that dislodges dirt and particles, even in the smallest of crevices.

 NOT recommended for delicate and micro instruments.

 Follow the manufacturer's guidelines for specific instructions and cleaning cycle times. Instruments should be processed for the full recommended cycle time.

Place instruments in the open position in the ultrasonic cleaner.

-  Do NOT allow instruments with sharp blades to touch other instruments.
-  Do NOT place dissimilar metals (stainless, copper, chrome plated) in the same cleaning cycle.
-  Make sure all instruments are completely submerged.

 After the ultrasonic cleaning cycle is complete, rinse instruments thoroughly to remove all ultrasonic cleaning solution.

 Dry instruments thoroughly with a clean towel.

 Use a spray lubricant in the hinges to minimize the risk of corrosion and maintain functionality.



Sterilization



It is important that instruments are free from all traces of organic or other matter prior to sterilization.

Steam Sterilization/Autoclaving

The autoclave process utilizes moist heat (or steam) under pressure for sterilization. The steam used must be from distilled water and free of all impurities.

 Lubricate all instruments that have any metal to metal interaction such as; scissors, rongeurs, needle holders, hemostats, and retractors. Do NOT use WD-40 or other industrial lubricants.

Instruments may be autoclaved individually or in sets.

-  Individual instruments: Disposable wraps or sterilization pouches are ideal. Make sure the pouch size is sufficient for the instrument to be in an open (unlocked) position.
-  Instrument sets: Open and unlock all instruments. Place the heavier instruments on the bottom of the set when two layers are needed.

 Do NOT lock instruments during autoclaving. This will prevent the steam from reaching and sterilizing the metal to metal surfaces, and heat expansion during autoclaving can cause cracks in the hinge areas.

 Do NOT over load the autoclave chamber as this may hinder steam penetration.

 Place a towel on the bottom of the pan to absorb excess moisture during autoclaving. Make sure the towel has no detergent residue and is pH neutral if immersed in water.

 At the end of the autoclave cycle (before the drying cycle) unlock the autoclave door and open it slightly. Run the dry cycle for the recommended time period by the autoclave manufacturer.

Please note: If the autoclave door is fully opened before the drying cycle, cold air will rush into the chamber, which can cause condensation on the instruments. This will result in water stains on the instruments.

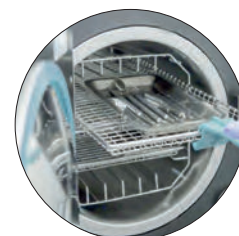



Hot Bead Sterilization

Recommended for speed and convenience when instrument tips or blade sterilization is required. The Hot Bead Sterilizer does not use dangerous gases, flames, or chemicals. Highlights:

- ⚠ Bench top set up.
- ⚠ Only 20 seconds of contact required to ensure your instruments are free of pathogens and microbial contaminants.
- ⚠ Beads reach temperature of 240° - 270°C (464° - 518°F) within 15-20 minutes heating time.

Please see page 158 – 159 for more information on the FST Hot Bead Sterilizers.



Ethylene Oxide (ETO) Sterilization

This method is recommended for instruments that will not tolerate high temperatures or moisture (e.g., catheters, cannulae, etc.). This is a process consisting of 4 primary variables; gas concentration, humidity, temperature and time. Sterilization pouches and wraps available, see pages 157 and 160.

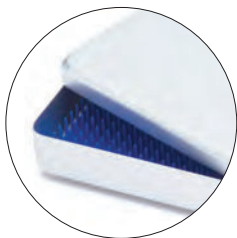

Storage

Surgical instruments should be properly stored in a clean and dry environment. It is highly recommended to use tip protectors and instrument cases to avoid possible damage to your instruments. Instrument tip protectors are available, see page 156. Instrument cases are available, see pages 162 – 165.



Oxidation (Rust)

All FST stainless steel surgical instruments are manufactured from medical grade stainless steel under strict European standards. It is very important to properly take care of your instruments to extend their lifespan.

Although stainless steel is corrosive resistant, it can still rust or stain if handled improperly. Under unfavorable conditions instruments may oxidize because stainless steel that is exposed to physical, thermal, or chemical manipulations may lose some of its stainless properties.

Quality Control

The high quality of Fine Science Tools surgical and microsurgical instruments is the result of our relentless attention to detail. Almost every instrument we sell is manufactured by skilled European craftsmen, designed to exacting specifications made from the finest German stainless steel alloys, and forged from the strongest, lightest materials available, and tested to ensure precision performance and ergonomics.

We are dedicated to quality control, with technicians in our German office inspecting most FST instruments. Aside from checking instrument dimensions and specifications, we thoroughly inspect tip sharpness, cutting edges, springs, joints, and other various components. Only after passing our detailed inspections, instruments are approved and sealed with our "FST Inspected" sticker.

We are proud to guarantee all of our products with your 100% satisfaction. If, for any reason, you are not completely satisfied with your purchase, you may return it for a full refund.



We Proudly Stock



Fine Science Tools is proud to offer a large selection of left-handed surgical instruments to the research community. To find our left-handed instruments in this catalog, look for the “left-handed” icon on the pages below.

Scissors: pages 17, 29

Hemostatic Forceps: page 99

Needle Holders: pages 119 – 120

Ligation Aid: page 143



FST features a selection of scissors with larger than normal finger loops. Most of these loops are easily adjustable to fit larger fingers more comfortably. To find our large loop scissors please look for the “large loop” icon on the pages below.

Scissors: pages 19, 28 and 31



Fine Science Tools has noted which items are most frequently purchased for use in a variety of surgical procedures. To find our most popular items, look for the “most popular” icon throughout the catalog.



Fine Science Tools offers a wide selection of the latest and most popular Dumont forceps. Hand crafted in Switzerland for more than a century, these forceps are known for their consistent and uncompromised fineness. Dumont forceps come in a wide array of styles and alloys. On page 217, you will find detailed descriptions to help guide you in choosing the right Dumont forceps best suited for your needs.



Moria of France is one of the most respected and well known ophthalmic instrument manufacturers in the world, offering some of the finest surgical instruments in the industry for almost 200 years.

Only quality Swedish and German stainless alloys are selected; and many hours of highly skilled labor are put into the manufacturing process, which includes hand crafted sharpening, balancing, and polishing, often done under 40x magnification. Moria’s product line includes scissors, spring scissors, forceps, spoons, vessel clamps, and more.



This Swiss manufacturer has established itself as one of the premier suppliers of superb microsurgical instruments worldwide. Unique designs, precise instrument balance, and optimum angles gives S&T instruments the “right feel” which is important for all procedures. S&T’s product line includes forceps, needle holders, scissors, vessel clamps, sutures, vessel cannulation forceps, vessel dilators, and more.

Finding the Dumont forceps best suited for your needs:



Alloys	Hardness	Magnetic	Temperature resistance	Autoclavable	Advantages
Titanium	Least Hard	No	Up to 430° C	Yes	Resistant to corrosion from nitric acid, chloride, and salt water. Titanium is 40% lighter than stainless steel.
Dumoxel	Hard	No	400° C	Yes	The most popular alloy available for Dumont forceps offers the best resistance to corrosion, sulphuric environments, hydrochloric acids, and all other mineral and organic acids.
Inox	Harder	Yes	400° C	Yes	Available for most Dumont forceps. Contains chromium added to carbon steel, which results in some loss of hardness but offers good stainless qualities and resistance to corrosion.
Dumostar	Harder	No	500° C	Yes	More durable and corrosion resistant than the best stainless steels. Highly resistant to mineral and organic acids, and salt water. Dumostar lasts an average of four times longer than Dumoxel and Inox. Most cost effective alloy for laboratory use.
Carbon	Hardest	Yes	N/A	No	Extremely hard; ensuring strong tips. Easily stains and rusts without proper care. Carbon cannot be immersed in a water bath or sterilized.

Tip profiles: Dimensions vary. See each style for specific dimensions (width x thickness).

Standard	Made for high precision and consistently precise work under a microscope.
Biology	Twice as fine as "Standard Tips." Especially produced for high precision laboratory work under the microscope.
Super Fine Tips	Four times finer than the "Standard Tips." These tips are extremely delicate for the finest work under the microscope. Extra care is needed for these tips as they are very fragile.

Styles

#2	Straight forceps with wide yet fine tips, referred to as Mouse Laminectomy Forceps because of their popularity in breaking off delicate bone from mouse skulls.
#2AP	Epoxy coated with flat wide blunt tips.
#3	Long straight forceps with coarse tips. Popular in low magnification procedures.
#3C	Shorter version of #3.
#4	Similar to the #5 but with broader shanks and stronger tips.
#5	Most popular style of Dumont straight forceps with fine tips which come in several styles.
#55	Similar to the #5 but with lighter shanks, giving the forceps a lighter spring action.
#5CO	Similar to the #55 but with even finer shanks producing the lightest spring action and longest meeting surface of any Dumont style.
#5L	Medical #5 forceps with slide sleeve for a secure hold and retention.
#5SF	The finest tips ever produced by Dumont.
#5XL	Extra Long #5 forceps.
#5/45	Tips angled at 45°.
#5/45C	Designed to pick up cover slips from multi-well plates.
#5/90	Tips angled at 90°.
#5AC	Self-closing Anti-Capillary forceps.
#6	Sharply angled, broad tips.
#7	Most popular style of Dumont curved forceps with fine tips which come in several styles.
#7B	Curved serrated tips.
AA	Strong broad tips.
M	Mini forceps.
Medical	Denotes distinctive ribbed handle to maximize grip.
SS	Long and narrow shanks with thin tips.
WA	One piece design with no soldering grooves allows the forceps to be thoroughly and easily cleaned preventing biofilm residue.

Item No.	Page No.										
		10030-13.....	106	10100-30.....	56	11002-18.....	91	11040-08.....	84	11200-10.....	74
		10031-13.....	106	10100-45.....	56	11002-20.....	91	11041-08.....	84	11200-12.....	74
		10032-13.....	106	10110-01.....	55	11002-25.....	91	11042-08.....	84	11200-14.....	74
00071-14.....	137	10033-13.....	106	10110-03.....	55	11003-12.....	91	11043-08.....	84	11200-33.....	73
00072-14.....	137	10035-00.....	58	10110-05.....	55	11003-13.....	91	11049-10.....	85	11203-23.....	73
00081-00.....	166	10035-05.....	58	10110-07.....	55	11003-14.....	91	11050-10.....	85	11203-25.....	73
00108-11.....	80	10035-10.....	58	10130-05.....	115	11003-16.....	91	11051-10.....	85	11210-10.....	73
00109-11.....	80	10035-12.....	58	10130-10.....	115	11003-18.....	91	11052-10.....	85	11210-20.....	73
00125-11.....	142	10035-15.....	58	10130-20.....	115	11003-20.....	91	11053-10.....	85	11215-01.....	42
00126-11.....	142	10035-20.....	58	10140-01.....	107	11006-12.....	89	11054-10.....	85	11215-02.....	42
00272-13.....	82	10035-25.....	58	10140-02.....	107	11006-15.....	83	11055-10.....	85	11220-21.....	72
00276-13.....	142	10035-30.....	58	10140-03.....	107	11008-13.....	92	11062-10.....	86	11223-20.....	72
00325-00.....	136	10050-00.....	57	10140-04.....	107	11008-15.....	92	11063-07.....	82	11229-08.....	74
00396-01.....	136	10052-11.....	57	10152-30.....	54	11009-13.....	92	11064-07.....	84	11229-10.....	74
00398-02.....	136	10053-09.....	57	10157-13.....	54	11009-15.....	92	11065-07.....	84	11231-20.....	70
00400-03.....	136	10053-13.....	57	10157-15.....	54	11010-17.....	97	11066-07.....	84	11231-30.....	70
00574-11.....	145	10055-12.....	52	10157-18.....	54	11011-17.....	97	11067-07.....	84	11241-30.....	72
00608-11.....	145	10056-12.....	52	10160-13.....	109	11012-18.....	97	11069-08.....	84	11242-40.....	72
00632-11.....	80	10058-15.....	53	10162-12.....	105	11012-21.....	97	11070-08.....	84	11251-10.....	67
00649-11.....	80	10059-13.....	52	10165-11.....	108	11012-25.....	97	11071-10.....	86	11251-20.....	67
10000-10.....	62	10059-15.....	53	10166-11.....	108	11013-18.....	97	11072-11.....	88	11251-21.....	68
10000-11.....	62	10060-00.....	62	10167-11.....	108	11013-21.....	97	11073-10.....	87	11251-23.....	67
10000-15.....	62	10060-13.....	62	10315-12.....	58	11014-18.....	96	11074-02.....	87	11251-30.....	67
10002-00.....	61	10061-12.....	107	10316-14.....	58	11015-18.....	96	11075-00.....	87	11251-33.....	69
10002-50.....	61	10062-12.....	107	10317-14.....	58	11016-17.....	97	11076-15.....	92	11251-35.....	69
10003-12.....	60	10063-15.....	106	10318-14.....	58	11017-17.....	97	11080-02.....	96	11252-00.....	65
10003-13.....	60	10064-14.....	107	10321-08.....	113	11018-12.....	89	11083-07.....	81	11252-20.....	67
10004-13.....	59	10065-15.....	106	10360-13.....	113	11019-12.....	89	11084-07.....	81	11252-21.....	68
10006-12.....	63	10066-15.....	106	10370-13.....	53	11020-12.....	89	11090-09.....	81	11252-23.....	67
10007-12.....	61	10073-14.....	52	10370-17.....	113	11021-12.....	94	11090-10.....	81	11252-30.....	67
10007-16.....	61	10075-16.....	51	10370-18.....	113	11021-14.....	94	11091-15.....	103	11252-40.....	67
10009-13.....	59	10080-05.....	51	10370-19.....	113	11021-15.....	94	11092-12.....	103	11252-50.....	65
10010-00.....	60	10081-10.....	51	11000-12.....	91	11022-12.....	89	11093-10.....	81	11253-10.....	68
10010-10.....	63	10082-15.....	51	11000-13.....	91	11022-14.....	94	11095-09.....	102	11253-20.....	66
10011-00.....	60	10083-20.....	51	11000-14.....	91	11022-15.....	94	11095-13.....	102	11253-21.....	66
10011-10.....	63	10087-12.....	110	11000-16.....	91	11023-10.....	94	11096-10.....	103	11253-25.....	66
10012-00.....	60	10088-15.....	109	11000-18.....	91	11023-12.....	94	11096-13.....	103	11253-27.....	69
10015-00.....	60	10089-11.....	110	11000-20.....	91	11023-14.....	94	11101-09.....	88	11253-29.....	66
10015-10.....	63	10090-13.....	109	11000-25.....	91	11023-15.....	94	11103-09.....	88	11254-20.....	65
10020-00.....	59	10090-17.....	109	11000-30.....	91	11024-18.....	97	11106-09.....	88	11255-20.....	67
10021-00.....	59	10091-12.....	110	11001-12.....	91	11025-18.....	97	11150-10.....	85	11258-20.....	74
10022-00.....	59	10092-12.....	110	11001-13.....	91	11026-15.....	95	11151-10.....	85	11260-20.....	70
10023-00.....	59	10093-13.....	110	11001-14.....	91	11027-12.....	89	11152-10.....	85	11270-20.....	71
10025-23.....	56	10094-13.....	110	11001-16.....	91	11028-15.....	95	11153-10.....	85	11271-30.....	71
10025-43.....	56	10095-12.....	51	11001-18.....	91	11029-14.....	94	11154-10.....	85	11272-30.....	71
10025-44.....	56	10096-16.....	51	11001-20.....	91	11030-12.....	90	11155-10.....	85	11272-40.....	71
10025-45.....	56	10097-16.....	51	11002-12.....	91	11031-15.....	95	11158-10.....	85	11272-50.....	71
10025-50.....	56	10098-06.....	111	11002-13.....	91	11032-12.....	89	11159-10.....	85	11273-20.....	66
10025-70.....	171	10099-12.....	112	11002-14.....	91	11036-20.....	97	11160-10.....	85	11273-22.....	66
10025-71.....	171	10099-15.....	112	11002-16.....	91	11036-90.....	97	11200-00.....	154	11274-20.....	71

11280-11145	11917-1275	12061-01 116	14002-1429	14060-0917	14111-15 34
11281-11145	11923-1376	12061-02 116	14002-1629	14060-1017	14111-17 34
11282-11145	11972-2076	12074-12 116	14003-1229	14060-1117	14116-14 33
11293-0070	11980-1376	12075-12 116	14003-1329	14061-0917	14116-18 33
11294-0072	11988-0176	12075-14 116	14003-1429	14061-1017	14117-14 33
11295-0067	11988-0276	12076-12 116	14003-1629	14061-1117	14117-18 33
11295-1067	11988-0376	12102-12 119	14003-1829	14062-0917	14130-17 30
11295-2065	11990-1475	12500-12 118	14003-2029	14062-1017	14131-14 31
11295-5167	11991-1475	12501-13 118	14004-1229	14063-0917	14160-10 17
11297-0071	11992-1275	12502-12 119	14004-1329	14063-1117	14161-10 17
11297-1071	11992-2076	12502-14 119	14004-1429	14064-1124	14171-10 28
11370-3178	12001-13 118	12503-15 120	14004-1629	14065-1124	14173-12 25
11370-3278	12002-12 119	12504-15 120	14004-1829	14066-1124	14184-09 15
11370-4078	12002-14 119	12505-15 121	14005-1229	14067-1124	14185-09 15
11370-4278	12003-15 120	12510-14 117	14005-1329	14068-1219	14200-21 35
11373-1278	12004-16 120	12512-12 119	14005-1429	14069-1219	14370-22 18
11373-2278	12004-18 120	12565-14 117	14005-1629	14070-1219	14370-23 18
11383-5079	12005-15 121	13002-10 102	14007-14 30	14071-1219	14501-14 30
11383-5679	12010-14 117	13003-10 102	14008-1429	14072-1027	14502-14 30
11390-2579	12018-12 125	13004-14 100	14010-15 34	14074-0923	14504-14 30
11393-0482	12020-00 127	13005-14 100	14010-17 34	14074-1123	14505-14 30
11393-0582	12020-09 127	13006-12 98	14011-15 34	14075-0923	14508-15 32
11399-8078	12022-09 127	13007-12 98	14011-17 34	14075-1123	14509-15 32
11399-8778	12022-19 127	13008-12 99	14012-15 35	14076-0926	14510-15 34
11412-1177	12023-00 127	13009-12 99	14012-17 35	14077-0924	14510-17 34
11413-1177	12028-12 125	13010-12 99	14013-15 35	14077-1024	14511-15 34
11445-1277	12029-12 125	13011-12 99	14013-17 35	14078-1022	14511-17 34
11480-1177	12030-01 126	13012-12 99	14014-17 35	14079-1022	14512-15 34
11485-1177	12030-04 126	13013-14 101	14015-17 35	14080-1127	14512-17 34
11487-1177	12030-20 126	13014-14 101	14016-14 33	14081-0926	14518-14 32
11506-1289	12030-22 126	13015-14 101	14016-18 33	14082-0926	14518-18 32
11515-0243	12030-23 126	13018-14 100	14017-14 33	14083-0815	14519-14 32
11602-1491	12035-00 126	13019-14 100	14017-18 33	14084-0815	14519-18 32
11602-1696	12040-01 125	13020-12 98	14018-13 32	14084-0915	14531-09 31
11608-1592	12040-02 125	13021-12 98	14018-14 32	14085-0815	14558-09 21
11616-1590	12040-03 125	13108-12 99	14018-18 32	14085-0915	14558-11 21
11617-1290	12050-01 123	13109-12 99	14019-13 32	14086-0927	14559-09 21
11626-1169	12050-02 123	14000-12 29	14019-14 32	14088-1018	14559-11 21
11627-1290	12050-03 123	14000-13 29	14019-18 32	14090-0916	14568-09 20
11650-1085	12050-10 123	14000-14 29	14024-14 33	14090-1116	14568-12 20
11651-1085	12050-20 123	14000-16 29	14028-10 22	14091-0916	14569-09 20
11652-1085	12051-08 122	14000-18 29	14029-10 22	14091-1116	14569-12 20
11700-0087	12051-10 122	14000-20 29	14037-10 28	14094-1116	14574-09 23
11700-0187	12051-11 122	14001-12 29	14040-10 19	14095-1116	14574-11 23
11700-0287	12052-08 122	14001-13 29	14041-10 19	14101-14 31	14575-09 23
11700-0387	12052-09 122	14001-14 29	14054-13 30	14105-12 25	14575-11 23
11700-0487	12052-10 122	14001-16 29	14058-09 20	14106-09 28	14958-09 21
11900-1483	12052-11 122	14001-18 29	14058-11 20	14108-09 28	14958-11 21
11911-1175	12060-01 116	14002-12 29	14059-09 20	14110-15 34	14959-09 21
11915-1175	12060-02 116	14002-13 29	14059-11 20	14110-17 34	14959-11 21

15000-00.....4	15370-508	16152-11..... 46	18000-51158	18051-28.....139	18132-12142
15000-016	15370-528	16152-12 46	18000-52159	18051-35.....139	18144-30139
15000-026	15371-92.....12	16152-15 46	18004-18.....167	18051-50.....139	18155-13 86
15000-033	15396-00.....5	16220-14 36	18004-23167	18052-01139	18196-10170
15000-043	15396-015	16221-14 36	18004-27167	18052-02139	18200-01135
15000-083	15400-12.....7	17000-01129	18004-50167	18052-03139	18200-02135
15000-104	15401-127	17000-02129	18010-00 168	18052-12 143	18200-03135
15000-116	15514-1210	17000-03129	18010-01 168	18053-28139	18200-04135
15000-126	15610-086	17000-04129	18010-02 168	18054-28139	18200-05135
15001-083	15615-086	17001-07132	18019-00 168	18055-01138	18200-06135
15002-083	15617-08.....6	17002-02129	18019-01 168	18055-02138	18200-07135
15003-084	15650-1111	17003-03129	18019-02 168	18055-03138	18200-08135
15004-084	15651-1111	17004-03129	18020-00123	18055-04138	18200-09135
15005-084	15750-117	17004-05130	18020-01123	18055-05138	18200-10135
15006-098	15751-117	17005-03129	18020-02123	18055-06138	18200-11135
15007-085	16000-14.....40	17005-04130	18020-03123	18056-14.....138	18200-12135
15008-084	16001-15.....37	17006-05132	18020-20123	18057-14138	18200-20135
15009-088	16002-18.....39	17007-08132	18020-30123	18058-15139	18200-50135
15010-0911	16004-16.....40	17008-07131	18020-40123	18058-18139	18320-11139
15010-1011	16005-16.....40	17009-07131	18020-50123	18060-20147	18374-43139
15011-1210	16015-1737	17009-08131	18020-60123	18061-10147	18374-44139
15012-1210	16016-1737	17010-07131	18020-70123	18061-15147	18403-11145
15013-1210	16020-14.....36	17011-10133	18025-1082	18061-18147	18406-11145
15015-1111	16021-1436	17012-11134	18026-1083	18061-20147	18406-13145
15017-1010	16022-1539	17012-13134	18030-30123	18061-22147	18555-01138
15018-104	16023-1539	17017-10133	18030-40123	18061-24147	18555-02138
15019-104	16025-1449	17018-11134	18030-50123	18061-38147	18555-03138
15020-157	16030-1246	17020-17128	18030-60123	18061-50147	18555-04138
15021-157	16030-1646	17021-13128	18030-70123	18061-75147	18601-1593
15023-109	16044-1046	17022-13128	18030-80123	18062-12143	18602-1593
15024-109	16050-1547	17023-13128	18035-01170	18062-13143	18603-1493
15025-109	16060-1150	17300-02130	18035-02170	18063-13143	18961-15148
15027-1812	16101-1044	17300-03130	18035-03170	18064-20147	18961-17148
15028-1812	16102-1144	17300-04130	18035-05170	18065-20147	18961-18148
15030-1413	16103-1143	17370-53130	18035-35170	18067-11105	18961-20148
15031-1413	16104-1448	18000-00169	18035-50170	18070-00140	18961-75148
15032-0814	16104-1948	18000-01169	18035-80170	18070-10140	18961-85148
15032-1314	16105-1648	18000-02169	18036-19170	18073-00140	19003-00176
15033-099	16106-1448	18000-03169	18036-22170	18080-01141	19003-01176
15036-1413	16107-1441	18000-04169	18036-24170	18080-02141	19007-05167
15037-1413	16109-1441	18000-10144	18038-45139	18080-03141	19007-07167
15040-119	16120-1436	18000-15153	18039-45139	18090-00166	19007-09167
15042-119	16121-1436	18000-18167	18040-00141	18090-45159	19007-14167
15070-085	16130-1547	18000-20167	18040-11136	18090-46159	19007-21167
15071-085	16140-1145	18000-30151	18040-14137	18090-50159	19007-29167
15110-0812	16141-1145	18000-35174	18040-22136	18090-51159	19008-07167
15111-0812	16142-1145	18000-45158	18040-33136	18105-01170	19008-09167
15123-126	16143-1245	18000-46158	18050-28139	18105-03170	19008-14167
15124-126	16144-1345	18000-47159	18050-35139	18106-01170	19009-0050
15300-0014	16150-2449	18000-50158	18050-50139	18131-12142	19009-05167

19009-07 167	24212-01 150	28001-02 160	29070-09 155	91127-12 196	91402-10 187
19009-09 167	24212-02 150	28015-15 160	29071-01 155	91128-15 198	91402-12 187
19010-00 50	24213-02 150	28015-25 181	29071-02 155	91138-15 198	91402-13 187
19010-01 50	24213-12 150	28020-20 160	29071-03 155	91139-09 195	91402-14 187
19010-10 50	24214-02 150	28020-28 181	29071-04 155	91139-12 195	91404-12 187
19010-11 50	24215-02 149	28030-02 177	29071-05 155	91150-20 193	91404-13 187
20311-21 164	24220-00 152	28030-03 177	29071-06 155	91156-11 195	91404-14 187
20325-00 161	24220-10 152	28030-04 177	29071-07 155	91162-12 196	91405-10 191
20325-10 161	24220-50 152	28030-10 177	29071-08 155	91191-15 205	91405-11 187
20330-00 165	24220-90 152	28030-20 180	29080-00 155	91194-10 203	91405-13 187
20330-01 165	24916-02 149	28030-25 180	30051-10 171	91194-13 203	91405-14 187
20330-02 165	26000-25 115	28040-30 179	30076-14 171	91195-09 203	91408-14 186
20330-03 165	26000-30 115	28050-30 179	30085-15 173	91195-11 203	91409-15 189
20350-00 161	26000-35 115	28050-35 179	30085-30 173	91195-13 203	91410-17 189
20810-01 162	26000-40 115	28080-10 178	30087-00 174	91196-13 204	91411-17 189
20810-02 162	26000-45 115	28080-90 179	30087-20 174	91197-00 193	91413-14 189
20820-00 162	26000-50 115	29000-00 154	37500-00 172	91198-15 205	91413-18 189
20830-00 165	26000-55 115	29000-10 153	37500-05 172	91199-16 205	91413-20 189
20830-01 165	26000-60 115	29000-10 182	91003-12 192	91201-13 206	91416-14 190
20830-02 165	26000-65 115	29008-01 153	91004-13 192	91204-16 206	91417-18 190
20830-03 165	26000-70 115	29008-12 153	91100-12 197	91303-10 199	91419-14 190
20830-04 165	26001-25 115	29008-22 154	91100-13 197	91304-14 200	91427-12 196
20830-05 165	26001-30 115	29015-50 153	91100-14 197	91304-16 200	91460-11 186
20830-06 165	26001-35 115	29015-50 182	91100-16 197	91305-14 200	91460-12 186
20831-10 166	26001-40 115	29025-01 175	91100-17 197	91305-16 200	91461-11 186
20840-01 163	26001-45 115	29025-02 175	91102-12 197	91308-12 199	91461-12 186
20840-02 163	26001-50 115	29026-10 175	91102-13 197	91309-12 199	91468-12 188
20840-03 163	26001-55 115	29027-00 173	91102-14 197	91316-14 201	91476-09 188
20842-03 163	26001-60 115	29051-45 153	91102-16 197	91316-16 201	91500-09 186
20850-00 164	26001-65 115	29055-00 154	91106-12 196	91317-14 201	91501-09 186
20850-10 164	26001-70 115	29060-00 156	91108-12 198	91317-16 201	91601-11 191
20850-11 164	26002-10 115	29060-01 156	91108-14 198	91318-14 200	91604-09 191
20890-51 164	26002-15 115	29060-02 156	91110-10 194	91319-14 200	91606-07 206
20890-71 164	26002-20 115	29060-03 156	91113-10 194	91322-14 201	91700-03 207
20890-72 164	26003-15 115	29060-04 156	91115-10 194	91323-14 201	91706-05 207
23005-10 124	26007-01 115	29060-05 156	91117-10 194	91328-14 202	91790-16 207
24201-00 152	26007-02 115	29060-06 156	91118-12 196	91328-16 202	91791-16 207
24201-01 152	26007-03 115	29066-00 156	91119-12 196	91329-14 202	91815-11 207
24202-01 151	26007-04 115	29066-01 156	91121-12 197	91329-16 202	91850-35 207
24202-02 151	26007-05 115	29066-02 156	91121-13 197	91330-14 202	
24202-03 151	26016-12 114	29066-03 156	91121-14 197	91331-12 199	
24202-04 151	26018-17 114	29066-04 156	91121-15 197	91331-14 202	
24202-05 151	26029-10 88	29070-01 155	91121-16 197	91393-16 204	
24202-06 151	26030-10 88	29070-02 155	91121-18 197	91400-10 187	
24202-11 151	26100-00 50	29070-03 155	91121-20 197	91400-12 187	
24202-12 151	27000-01 176	29070-04 155	91121-25 197	91400-14 187	
24202-13 151	28000-07 157	29070-05 155	91123-12 197	91401-10 187	
24202-14 151	28000-10 157	29070-06 155	91123-14 197	91401-12 187	
24202-15 151	28000-12 157	29070-07 155	91123-16 197	91401-13 187	
24202-16 151	28001-00 160	29070-08 155	91126-15 198	91401-14 187	

Alphabetical Index

A

Absorption Spears and Triangles	170
Adson forceps.....	89-90
Adson.....	89
Adson-Brown.....	90
Adson DeBakey.....	90
Adson-Graefe.....	90
Micro Adson.....	89
Micro Adson Fenestrated.....	89
Agricola retractor.....	130
Allis hemostatic forceps.....	103, 205
Alm retractors.....	131
Applicators.....	
Horizon ligation system.....	140
Micro serrefine.....	137-138
Suture clips.....	125-127
Applying forceps, clamp.....	137-138
Arc blade.....	58
Arteriotomy knives.....	52-53, 55-56
Artery scissors.....	27
Austin Chisel.....	51
AutoClip® System.....	127

B

Baby-Beyer.....	39
Baby-Mixer hemostatic forceps.....	101
Backhaus towel forceps.....	102
Balanced Instruments.....	93
Ball Tipped.....	
Spring Scissors.....	9
Scissors.....	27
Beebee bone scissors.....	46
Beyer rongeurs.....	39
Biemer spring scissors.....	14
Biemer vascular clip.....	139
Bishop-Harman forceps.....	84
Bonn-Strabismus scissors.....	15
Blade.....	
Breakers.....	57
Cartridges.....	63
Holders.....	56-63
Blades.....	
Breakable.....	57
Ceramic.....	56
Diamond.....	56
Obsidian.....	55
Scalpel.....	58-60, 62-63
Blair retractor.....	128
Boehler bone cutter.....	47
Bone.....	
Cutters.....	41-48

Delicate scraper.....	51
Forceps.....	50
Nipper.....	44-45
Pliers.....	49
Rongeurs.....	36-40
Scissors.....	45-46
Scissors, Student.....	191
Scraper.....	51
Screws, self-tapping.....	50
Shears.....	49
Wax.....	50
Bone cutters.....	
Beebee.....	46
Bone Trimmers.....	41
Boehler.....	47
Cartilage Cutter.....	42-43
Cleveland.....	48
Dumont carbon steel.....	42
Dumont epoxy coated.....	42
Liston.....	48
Littauer.....	46
Malleus Nipper.....	45
Micro.....	43
Offset Bone Nipper.....	44
Skull Flap.....	47
Spring Scissors.....	45
Tungsten Carbide.....	43, 46
Bone Nipper.....	44
Bonn.....	
Artery.....	27
Forceps.....	79, 81
Micro probes.....	106
Moria.....	79
Scissors.....	15, 27
Strabismus.....	15
Book and DVD-Suturing Principles.....	124
Bowman retractor.....	132
Brush.....	170
Bulldog clamps.....	139
Burrs.....	167

C

Calipers.....	
Castroviejo.....	174
Digital electronic.....	174
Plastic Vernier.....	174
Cane blade.....	58
Cannulation aids.....	145
Cartilage Cutter.....	42-43
Cases, instrument.....	162-166
Castroviejo.....	
Caliper.....	174
Needle holders.....	116-117

Spring scissors.....	8-11
Cauterizer.....	
High Temperature.....	168-169
Low Temperature.....	168
Tips.....	168-169
CeramaCut, scissors.....	21
Ceramic.....	
About.....	211
Blades.....	56
Cutter.....	171
Dumont forceps.....	65, 71
Scissors.....	21
Spring scissors.....	7, 11
Titanium Spring Scissors.....	11
Chisels.....	
Austin.....	51
Dissecting.....	51
Circle forceps.....	88
Circle knife.....	53
Clamps.....	
Applying forceps.....	137-138
Bulldog Artery Spring Clamps.....	139
Bulldog Type Serrefines.....	139
Dietrich Bulldog Clamps.....	139
Double Micro Clamps.....	136
Horizon Ligation Clamps.....	140
Micro Serrefines.....	138
Mini Serrefines.....	139
Moria.....	139
S&T.....	136
Schwartz Micro Serrefines.....	139
Silver Neuro Clips.....	141
Student.....	199-105, 207
Titanium.....	138-139
Towel.....	102-103, 203-204
Vascular.....	136, 138-141
Vascular Occluders.....	141
Cleveland bone cutters.....	48
Clip-On LED Light.....	180
Clipper style scissors.....	14
Cohan-Vannas spring scissors.....	6
Colibri retractor.....	
Colibri.....	129
Mini.....	129
Moria.....	130
Combination Probe and Spatula.....	109
Combination Spoon and Spatula.....	109
Components forceps, Dumont.....	74
Contacts, Gold wire.....	176
Corers, sample.....	170
Cover glass forceps.....	87
Cover slip forceps.....	69
Crile hemostatic forceps.....	100

Crile-Wood needle holders	120
Curettes, micro	51
D	
DeBakey	
Adson	90
Round Handle	92
Decapitation scissors	35
Demagnetizer	153
Diamond coated forceps	75
Diamond knives	56
Dietrich bulldog clamps	139
Digital Electronic Caliper	174
Dilator, vessel	142
Disposable safety scalpels	62-63
Disposable scalpel box	61
Dissecting Chisel	51
Dissecting knives	52-53
Double-Ended Micro Spatula	110
Double Micro Clamps	136
Double pronged tissue pick	105
Double tip protectors	156
Dowell spring scissors	9
Dressing forceps	81, 84-92
Dumont	
Bone Cutter	42
Ceramic	65, 71
Components forceps	74
Coverslip	69
Epoxy	72-73
Forceps	42, 65-74, 193
Forceps sharpening stones	154
Laminectomy	72
Mini Forceps	74
Slide Lock	69
Super Fine Tip	65
Teflon	69
Titanium	67, 71
Tweezers	65-74, 193
Dura cutting knife	52
Dura hook	105

E	
Ear	
Punches	149-150
Tags	152
Tattoo system	152
Electronic timers	176
Etched micro needles	115
Eschenbach magnifiers	179-181
Extra Fine Bonn	15
Explorers	107

F	
Feeding needles	147-148
File set	171
Filters, sterilization	164
Fine	
Bonn	15
Forceps	75-85
Hemostats	98-99
Iris Scissors	16-21
Scissors	15-28
Spring scissors	3-14
Fixation forceps, Pierse	86
Fomon retractor	128
Forceps	
Adson	89-90, 196
Adson-Brown	90, 196
Adson DeBakey	90
Adson-Graefe	90
Applying and removing	125
Bishop-Harman	84
Bone	50
Bonn	79, 81
Cannulation	145
Ceramic	65, 71
Circle	88
Components	74
Cover glass	87
Cover slip	69
Cross action	77, 87
DeBakey, round handle	92
Diamond coated	75
Dressing	81, 84-92
Dumont	42, 65-74, 193
Epoxy coated	72-73
Fine	75-85
Fixation	86
Gerald	96
Gillies	95
Gold plated	75
Graefe	84-85
Grasping	83
Hemostatic	98-102
Insect handling	88
Laminectomy	72
London	96
Micro	65-78
Mirror Finish	67, 77
Moria	78-79, 82
Mouse laminectomy	72
Mouse handling	97
Multipurpose	93
Narrow Pattern	91
Octagon	84

Organ holding	88, 95
Paufigue forceps	79
Pierse fixation	86
Plastic	87
Potts-Smith	97
Repair kit	154
Replaceable Plastic Tip	76
Ring	88
Round Handle	83, 92-93
Russian	95
S&T	80, 82, 145
Self-Closing	77, 87
Semken	92
Standard Forceps	86-97
Standard Pattern	91
Student	193-198, 207
SuperGrip	80
Suture tying	81-83
Taylor	97
Titanium	67, 71, 78, 85, 91-92, 96
Troutman	82
Tungsten carbide	43, 89
Vitro Grasping	83
Vial	83
Friedman rongeur	40
Friedman-Pearson rongeur	36

G	
Galilean Loupes	179
Gavage feeding needles	147-148
Gelpi retractor	133
GenoPunch	149
Gerald forceps	96
Gillies forceps	95
Gold plated forceps	75
Gold wire contacts	176
Goldstein	
retractor	129
retractor Mini	129
Graefe	
Forceps	85
Knife	52
Grasping forceps	83
Grease, silicone	153
Gross anatomy	
Knives	54
Probe	109
Scalpel	62
Scissors	29-35
Guthrie retractor	128

H	
Halsey needle holders	118, 206

Halsted-Mosquito hemostatic forceps	99, 199
Handles, scalpel	56-63
Hardened Fine Iris Scissors	16
Hartman hemostatic forceps	102, 199
Headband magnifier	177
Headband, spectacles	178-179
Heiss retractor	133
Hemostatic forceps	
Allis Clamp	103, 205
Babcock	204
Baby-Mixer	101
Backhaus Towel Clamp	102, 203
Crile	100, 200
Fine	98
Halsted-Mosquito	99, 199
Hartman	102, 199
Hose Clamp	205
Kelly	100, 200
Kocher	202
Left-handed	99
Lister Sine Clamp	205
Lorna Towel Clamp	103, 204
Micro-Mosquito	99
Ochsner-Kocher	202
Pean	201
Providence-Hospital	101
Rochester-Pean	201
Smooth	98
Student	199-205
Tohoku Towel Clamp	203
Ultra Fine	98
Hippocampal dissecting tools	112
Holders	
Blade	56-63
Ceramic blade	56, 171
Micro needle	114, 206
Needle	116-121, 206
Pin	114, 206
Scalpel blade	56-63
Student	206
Hooks	
Micro	105-108
Spinal cord	105
Y-Hook	108
V-Hook	143
Horizon Ligation System	140
Hose Clamp	205
Hot bead sterilizers	158-159
I	
Identification	
Ear punches	149-150
Ear tags	152

Marker	151
Tattoo system	152
Insect	
Handling forceps	88
Pins	115
Insert	
Pin holders	114, 206
Pins	115
Instrument	
Beaker	166
Cases	162-166
Holding spring	166
Oil	154
Sharpening Stones	153-154
Tape, identification	155
Tip protectors	156
Iridectomy scissors	4-13, 16-21
Iris Spatulae	110
K	
Kaye scissors	28
Kelly hemostatic forceps	100
Knives	
Cataract	52
Circle	53
Diamond	56
Dura cutting	52
Gross anatomy	54
Gross anatomy (blade)	62
Micro	52-53
Obsidian	55
Sichel	52
Side Cut	53
Stone age	55
Von Graefe	52
L	
LaGrange scissors	25
Laminectomy forceps, mouse	72
Large Loops	19, 28, 31
Left-handed	
Fine scissors	17
Hemostatic forceps	99
Ligation aid	143
Needle holders	119-120
Surgical scissors	29
Lempert rongeur	40
Lens paper	153, 182
Lexer-Baby scissors	22
Ligation aid	143
Ligation system	140
Ligature scissors	26, 188
Lister scissors	31, 189

Lister sine clamp	205
Liston gross anatomy cutter	48
Littauer bone cutter	46
Live Insect Handling Forceps	88
Long-term textile filter	164
Lorna clamp	103, 204
Low Temperature Cauterizer	168
Lubricant, silicone	153
Luer rongeur	37
M	
Magnetic sterilization mat	161
Magnifiers	
Eschenbach Clip-On LED Light	180
Galilean Loupes	179
Headband	177
Interchangeable Headset with LED	178
Magnifying Loupe with Micrometer	
and LED	175
Spectacles	178-180
Stands	181
Scribolux	181
Vario Flex	181
Malleus Nipper	45
Mandrel	167
Manipler®, skin stapler	126
Manual and DVD, Suturing Principles and Techniques in Laboratory Animals	124
Marker, skin, fur	151
Mat, silicone	161
Mathieu needle holder	117
Max Detail spectacles	180
Mayo scissors	34, 189
Mayo-Hegar needle holder	116
Mayo-Noble scissors	35
Mayo-Stille scissors	35
Metzenbaum scissors	
Baby scissors	32
Fino	32
Scissors	33
Student	190
ToughCut	33
Tungsten Carbide	32
Michel	
Suture Clips	125
Applying and Removing	125
Micro	
Bone cutter	43-45
Cannulation System	144
Cleaning Brush	170
Curettes	51
Dissecting knives	52-53
Dissection scissors	3-14

Forceps	65-78
Hooks	106-107
Needles, etched	115
Needle holders	116
Needles and sutures	122-123
Points	106, 108
Probes	106, 108
Rongeurs	36-37
Serrefine applicators	137-138
Serrefines	136, 138-139
Spatulae	108, 110-111
Vannas	3-4
Micrometers	175
Micro-Mosquito Hemostat	99
Mini-Biemer spring scissors	14
Mini-Colibri retractor	129
Mini-Lister	31
Mini-Vannas spring scissors	3-5
Minutien pins	115
Mirror finish	
Cutting spoon	113
Forceps	67, 77
Micro spatula	110
Moria	
Forceps	78-79, 82
Instrument case	164
Pin holders	114
Retractors	130
Scissors	18
Spoons	113
Spring scissors	5, 8, 12
Vascular clamps	139
Mosquito hemostatic forceps	99, 199
Mouse	
Feeding needles	147-148
Laminectomy forceps	72
Handling forceps	97
Multipurpose forceps	93

N

Narrow Pattern Forceps	91
Needle Holders	
Castroviejo	116-117
Crile-Wood	120
Halsey	118
Mathieu	117
Mayo-Hegar	120
Olsen-Hegar with Suture Cutter	119
Round Handled	116
Ryder Mini	121
Slim Elongated	121
with Suture Cutter	116, 119
Needles	

Etched, micro	115
Feeding	147-148
Micro needles and sutures	122-123
Neuro punches	170
Neuro clips, silver	141
Noyes spring scissors	10
Nylon suture thread	123

O

Obsidian scalpels	55
Occluders, vascular	141
Octagon Forceps	84
Offset Bone Nipper	44
Oil, instrument	154
O-rings for forceps	154
Olsen-Hegar needle holders	19
Optical cleaning kit	153, 182
Organ holding forceps	88, 95

P

Pascheff-Wolff spring scissors	12
Paufique forceps	79
Pearson rongeur	37
Pen, Marker	151
Perforated Spoons	113
Pick, Double Pronged	104
Pierse fixation forceps	86
Pin holders	114, 206
Pins	
Etched Tungsten Micro Needles	115
Insect	115
Insert	115
Minutien	115
Plastic cases	165
Plastic forceps	87
Plastic sterilization container	162-163
Plastic Vernier Caliper	174
Potts-Smith forceps	97
Pouches, sterilization	157
Probes	
Bonn Micro	106
Combination Probe and Spatula	109
Gross Anatomy	109
Micro Hooks	106-107
Micro Points	106, 108
Probes and Explorers	107
Vessel Dilating	109
Providence-Hospital hemostatic forceps	101
PTFE feeding needles	148
Punches	
Ear	149-150
Neuro	170

R

Repair kit, forceps	154
Replaceable	
Forceps	76
Ear punch	150
Retractors	
Agricola	130
Alm	131
Blade	129-132
Blair	128
Bowman	132
Colibri	129-130
Fomon	128
Hand	128
Heiss	133
Gelpi	133
Goldstein	129
Guthrie	128
Large	131-134
Mini-Goldstein	129
Mini-Colibri	129
Moria	130
Slide	129
Small	129-130
Speculum	130
Spring-Loaded	130, 132
Student	207
Systems	135
Weitlaner-Locktite	134
Wire	129-130, 132
Wullstein	134
Ring forceps	88
Roll up travel case	166
Rongeurs	
Baby-Beyer	39
Beyer	39
Bone	36-41
Friedman	40
Friedman-Pearson	36
Lempert	40
Luer	37
Micro	36
Pearson	37
Round Handled	
DeBakey forceps	92
Multipurpose forceps	93
Needle holder	116
Spring scissors	7
Suture tying forceps	83
Rulers	
Label Tape	173
Steel	173
Russian forceps	95

S

S&T		Standard Pattern.....	29, 31	Spring scissors	
Cannulation forceps.....	145	Stevens Tenotomy.....	24	Angled	3-4, 6, 8-13
Forceps.....	80, 82, 137, 142, 145	Strabismus	23	Ball Tipped	9
Instrument beaker.....	166	Student.....	186-191	Biemer	14
Micro needles and suture.....	122	Student Lister.....	189	Bone Cutter	45
SuperGrip forceps.....	80	Surgical.....	29-35	Castroviejo	8-11
Suture tying forceps	82	Titanium	6, 11	Ceramic coated	7, 11
Vascular clamps	136	ToughCut	6, 15, 20-21, 30, 33-34	Clipper Scissors II	14
Vessel dilator	142	ToughCut with tungsten carbide.....	21	Cohan-Vannas	6
Safety scalpel.....		Tungsten carbide.....	10, 20-21, 23, 30-32, 34,46	Dowell	9
Blade cartridges.....	63	Universal	172	Extra fine.....	3-7, 13-14
Disposable.....	62	Utility.....	172	Iridectomy.....	3-14
Handle	63	Vitrectomy.....	13	Micro-Vannas.....	3-4
Sample corers.....	170	Walton.....	24	Mini-Vannas	5
Saw, Circular.....	167	Screwdrivers.....	171	Moria.....	5, 8, 12
Scalpel		Screws, self-tapping	50	Noyes.....	10
Blade handles.....	56-63	Secure scalpel handle	60	Pascheff-Wolff.....	12
Blade removers	61	Self closing forceps.....	77, 87	Round Handled.....	7
Blades.....	56-60, 62-63	Self-Sealing Sterilization Pouches	157	Serrated.....	5
Ceramic blades.....	56	Semken forceps.....	92	Student Vannas.....	186
Disposal Box.....	61	Serrefines	138-139	Titanium Vannas	6, 11
Disposal Safety.....	62	Sharpening stones.....	153-154	ToughCut	6
Gross anatomy	62	Shea scissors.....	25	Trident II	12
Obsidian.....	55	Shears, bone.....	49	Vannas.....	3-8, 186
Safety.....	62-63	Sichel knife	52	Vannas-Miniature	6
Stone age	55	Silicone lubricant.....	153	Vannas-Tubingen.....	4
Schwartz micro serrefine.....	139	Silicone mats	161	Vannas-Wolff	8
Scissors.....		Silicone tips, forceps.....	97	Vessels	14
Bone.....	45-46	Silk sutures	123	Vitrectomy.....	13
Bonn.....	15, 27	Skin marker	151	Wescott.....	11
CeramCut.....	21	Skin staplers	125-127	Spring, instrument holding.....	166
Clipper	14	Skull flap cutter	47	Stage micrometers	175
Decapitation.....	35	Slide retractors.....	129	Standard Pattern Forceps	91
Dissector	26	Spatulae.....		Standard Pattern Scissors	
Dowell	9	Combination Spoon and Spatula.....	109	Large Loops	31
Fine	15-28	Combination Probe and Spatula.....	109	Scissors	29-31
Kaye.....	28	Double-Ended Micro Spatula	110	Serrations.....	30
LaGrange	25	Hippocampal Dissecting Tool.....	112	ToughCut	30
Large loops.....	19, 28, 31	Iris Spatulae	110	Tungsten Carbide	30
Left-handed.....	17, 29	Micro Spatula.....	108, 110-111	Staplers, skin.....	125-127
Lexer-Baby.....	22	Micro Spatula Kit.....	111	Sterilization	
Ligature	26, 188	Mini Hippocampal Dissecting Tool	112	Container.....	162-164
Lister.....	31, 189	Mirror Finish Micro Spatula	110	Hot Bead Sterilizer	158-159
Mayo.....	34, 189	Spears, absorption	170	Mats	161
Mayo-Noble	35	Spectacles Headband	179	Pouches	157
Mayo-Stille.....	35	Spectacles, magnifier	178-180	Tape	160
Metzenbaum	32-33, 190	Spencer Ligature	26, 188	Wraps	160
Mini-Lister.....	31	Spinal Cord Hook.....	105	Stevens tenotomy scissors	24
Moria	5, 8, 12, 18	Spoons		Stone Age Scalpels	55
Shea.....	25	Mini Perforated.....	113	Strabismus.....	23
Spencer Ligature.....	26, 188	Mirror Finish Cutting.....	113	Student	
Spring.....	3-14	Moria	113	Adson, micro, -Brown forceps.....	196
		Perforated	113	Allis clamp.....	205

Babcock clamp	204	Nylon	123	Forceps	43, 89
Backhaus towel clamp	203	S&T micro needles and suture	122	Mayo	34
Barraquer retractor	207	Suturing Principles and Techniques in		Metzenbaum Fino	32
Bone Scissors	191	Laboratory Animals, Manual and DVD	124	Needle holders	117-121
Bone Cutter	191	Thread	122-123	Noyes	10
Clamps	207	Tying forceps	79-83	Scissors	10, 20-21, 23, 30-32, 34, 46
Crile hemostat	200	With needle and thread	122	Scissors with ToughCut	21
Dieffenbach clamp	207	Swabs, Fiber Optic	170	Standard Pattern	30
Dumont forceps	193	T		Strabismus	23
Feilchenfeld forceps	195	Tags, Ear	152	Tweezers, Dumont	43, 65-74, 145, 193
Forceps	193-198	Tape		U	
Gillies forceps	198	Dispenser	160	Ultra Fine Clipper Scissors II	14
Halsey needle holder	206	Identification	155	Ultra Fine Hemostat	98
Halsted-Mosquito hemostat	199	Sterilization	160	Utility scissors	172
Hartmann hemostat	199	Ruler Label	173	V	
Hemostatic forceps	199-205	Tattoo system	152	Vannas	
Hose clamp	205	Taylor forceps	97	Cohan-Vannas	6
Instruments, About	185	Timers	174	Micro	3-4
Kelly hemostat	200	Tip protectors	156	Microserrations	5
Kocher hemostat	202	Tissue		Mini	5
Lister scissors	189	Pick	105	Round handled	7
Lister sine clamp	205	Scissors	27	Spring scissors	3, 8, 186
Lorna towel clamp	204	Titanium		Student	186
Mayo scissors	189	About	211	Titanium	6
Mayo-Hegar needle holder	206	Artery clamp	139	Vannas-Tübingen	4
McIndoe forceps	198	Ceramic coated spring scissors	11	Vannas-Wolff	8
Metzenbaum, baby scissors	190	Forceps	67, 71, 79, 84, 91-92, 96	Vascular clamps	136, 138-139
Needle holder	206	Micro Point	108	Vascular occluders	141
Ochsner-Kocher hemostat	202	Micro Spatula	108	Vernier caliper	174
Pean hemostat	201	Scissors	6, 11	Vessel cannulation aids	93, 142, 145
Pin holder	206	Serrefines	138	Vessel cauterizer	168-169
Retractor	207	Vascular Clamps	138-139	Vessel dilating probe	109
Rochester-Pean hemostat	201	Y-Hook	108	Vessel dilators	93, 109, 142
Russian forceps	198	Tools	171	Vessel spring scissors	14
Sanvenero scissors	186	ToughCut		Vetro grasping forceps	83
Scalpel handle	192	About	211	Vial forceps	83
Scissors	186-191	Bonn-Strabismus	15	VisorLight	177
Semken forceps	198	Mayo	34	Vitreotomy scissors	13
Senn-Miller retractor	207	Metzenbaum	33	V-Hook	143
Spencer ligature scissors	188	Scissors	6, 15, 20-21, 30, 33-34	Von Graefe knife	52
Splinter forceps	195	Spring scissors	6	W	
Spring scissors, Vannas	186	Scissors with tungsten carbide	21	Wagner	19
Tohoku towel clamp	203	Standard Pattern	30	Walton	24
Vessel dilator	207	Travel case	166	Wax	50
Wagner scissors	188	Trepines	167	Weitlaner-Locktite retractor	134
SuperGrip forceps	80	Trident II spring scissors	12	Westcott spring scissors	11
Surgical scissors	29-35	Troutman tying forceps	82	Wire contacts, gold	176
Left-handed	29	Tungsten needles, etched	115	Wire teeth retractor	131
Surgical table	135	Tungsten carbide		Wound Closure	116-127
Suture		About	211	Wraps, sterilization	160
Clips, AutoClip	127	Burrs	167	Wullstein retractor	134
Clips, Michel	125	Cutter	42-43		
Needles	122-123				

Fine Science Tools Online

Helping you find and buy the right tools

Whether you contact us at our offices, through dealers, or online—our priority is customer service. As part of that service, we have a variety of features to help you research, quote, and purchase Fine Science Tools products at **finescience.com**. These features enhance and streamline your shopping experience by helping you:

Quickly identify products by type and attributes with advanced search

Get detailed specs and enlarged product views

Use the extensive FAQs and pop-up glossary

Save quotes and convert to orders online

Pay with credit card or purchase order*

View your online order history

Track your shipments

*Payment by purchase order is available only for customers with a Net 30 account.

Our website is more engaging and informative than ever.



Zoom
Feature



High-Resolution
Images



Multi-Language
Support



Updated
Event Listings

We are continuously adding new products to our inventory.
Visit **finescience.com** to view all of our products.

All of our European suppliers are ISO 9001 certified.

All FST surgical instruments are made from the finest German stainless steel alloys (unless otherwise noted) and manufactured by skilled European craftsmen.

Most surgical instruments are shown actual size. As these instruments are handcrafted, dimensions may vary slightly from those stated in this catalog.

THE INFORMATION IN THIS CATALOG IS ACCURATE TO THE BEST OF OUR KNOWLEDGE. DESIGNS, STYLES AND DIMENSIONS DEPICTED IN THIS CATALOG ARE SUBJECT TO CHANGE WITHOUT NOTICE. ALL RECOMMENDATIONS OR SUGGESTIONS ARE MADE WITHOUT GUARANTEE, AND WE DISCLAIM ANY LIABILITY INCURRED IN CONNECTION WITH ANY RECOMMENDATION. WITH THE PURCHASE OF ANY PRODUCT FROM THIS CATALOG THE USER ASSUMES ALL RISKS AND LIABILITIES WHATSOEVER IN THE USE OF SUCH PRODUCTS. NEITHER SELLER NOR MANUFACTURER SHALL BE LIABLE IN TORT OR CONTRACT FOR ANY LOSS OR DAMAGE (DIRECT, INCIDENTAL, OR CONSEQUENTIAL) ARISING OUT OF THE USE, MISUSE, OR INABILITY TO USE SUCH PRODUCT.

FST IS A REGISTERED TRADEMARK OF FINE SCIENCE TOOLS INC. FINE SCIENCE TOOLS, TOUGH CUT, CERAMA CUT, AND FINE SURGICAL INSTRUMENTS FOR RESEARCH ARE TRADEMARKS OF FINE SCIENCE TOOLS INC. FST, TOUGH CUT, AND CERAMA CUT ARE REGISTERED TRADEMARKS OF FINE SCIENCE TOOLS (USA) INC. FINE SCIENCE TOOLS AND FINE SURGICAL INSTRUMENTS FOR RESEARCH ARE TRADEMARKS OF FINE SCIENCE TOOLS (USA) INC. FINE SCIENCE TOOLS AND FST ARE REGISTERED TRADEMARKS OF FINE SCIENCE TOOLS GMBH.

© COPYRIGHT 2023 THE TEXT, PHOTOS AND DRAWINGS CONTAINED IN THIS CATALOG ARE PROPRIETARY TO FINE SCIENCE TOOLS INC. AND MAY ONLY BE COPIED, DUPLICATED OR OTHERWISE REPRODUCED WITH THE WRITTEN CONSENT OF FINE SCIENCE TOOLS INC.



Scissors, Bone Instruments,
Knives & Scalpels
pages 3 – 63



Forceps & Hemostats
pages 65 – 103



Probes, Needle Holders, Thread,
Retractors & Clamps
pages 105 – 145



Surgical & Laboratory
Accessories
pages 147 – 183



Student Quality Instruments
pages 186 – 207



Reference Pages
pages 209 – 227



Fine Science Tools Inc.

410-197 Forester Street
North Vancouver, British Columbia
Canada V7H 0A6

Telephone +1 800-665-5355 / +1 604-980-2481

Fax +1 800-665-4544 / +1 604-987-3299

E-Mail canada@finescience.com

Web finescience.ca



Fine Science Tools (USA) Inc.

4000 East 3rd Avenue, Suite 100
Foster City, CA 94404-4824
USA

Telephone +1 800-521-2109 / +1 650-349-1636

Fax +1 800-523-2109 / +1 650-349-3729

E-Mail info@finescience.com

Web finescience.com



Fine Science Tools GmbH

Vangerowstraße 14
69115 Heidelberg
Germany

Telephone +49 62 21 - 90 50 50

Fax +49 62 21 - 90 50 590

E-Mail europa@finescience.de

Web finescience.de

InterFocus Ltd.

Cambridge Road
Linton, CB21 4NN
Great Britain

Telephone 01223 894833

E-Mail sales@surgicaltools.co.uk

Web www.surgicaltools.co.uk



InterFocus
surgicaltools.co.uk